

TravelMate C100

Service Guide

Service guide files and updates are available on the CSD web; for more information, please refer to <http://csd.acer.com.tw>

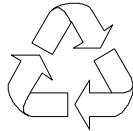

100% Recycled Paper

Revision History

Please refer to the table below for the updates made on Travelmate C100 service guide.

Date	Chapter	Updates
02/07/2002	Chapter 2	Delete FDD specification under System Information both in screen and on table.
	Chapter 3	Under "Disassembly Procedure Program" the center hinge block was deleted.
		Under "Removing the Middle Cover" the procedure was modified with an additional "Note" under it.
Under "Removing the LCD Hinges with the Center Hinge" the procedure was modified and also a "Note" was added.		
02/27/2002	Appendix B	Revise test compatible components.
03/05/2002	Chapter 1	Change audio controller, battery package voltage and modify system block diagram.
	Chapter 5	Modify connector description of CN14 and CN18.
05/18/2002	Chapter 1	Add upgradeable memory under "Expansion" section.
06/03/2002	Chapter 3	Add a "Note" for "Removing the LCD"
	Chapter 6	Update the LCD Bezel and the LCD
09/13/2002	All	Change model name from TravelMate 100 to TravelMate C100
		Update keyboard specs.
		Modify System Information and Startup configuration

Copyright

Copyright © 2002 by Acer Incorporated. All rights reserved. No part of this publication may be reproduced, transmitted, transcribed, stored in a retrieval system, or translated into any language or computer language, in any form or by any means, electronic, mechanical, magnetic, optical, chemical, manual or otherwise, without the prior written permission of Acer Incorporated.

Disclaimer

The information in this guide is subject to change without notice.

Acer Incorporated makes no representations or warranties, either expressed or implied, with respect to the contents hereof and specifically disclaims any warranties of merchantability or fitness for any particular purpose. Any Acer Incorporated software described in this manual is sold or licensed "as is". Should the programs prove defective following their purchase, the buyer (and not Acer Incorporated, its distributor, or its dealer) assumes the entire cost of all necessary servicing, repair, and any incidental or consequential damages resulting from any defect in the software.

Acer is a registered trademark of Acer Corporation.

Intel is a registered trademark of Intel Corporation.

Pentium and Pentium II/III are trademarks of Intel Corporation.

Other brand and product names are trademarks and/or registered trademarks of their respective holders.

Conventions

The following conventions are used in this manual:

Screen messages	Denotes actual messages that appear on screen.
NOTE	Gives bits and pieces of additional information related to the current topic.
WARNING	Alerts you to any damage that might result from doing or not doing specific actions.
CAUTION	Gives precautionary measures to avoid possible hardware or software problems.
IMPORTANT	Reminds you to do specific actions relevant to the accomplishment of procedures.

Preface

Before using this information and the product it supports, please read the following general information.

1. This Service Guide provides you with all technical information relating to the BASIC CONFIGURATION decided for Acer's "global" product offering. To better fit local market requirements and enhance product competitiveness, your regional office MAY have decided to extend the functionality of a machine (e.g. add-on card, modem, or extra memory capability). These LOCALIZED FEATURES will NOT be covered in this generic service guide. In such cases, please contact your regional offices or the responsible personnel/channel to provide you with further technical details.
2. Please note WHEN ORDERING FRU PARTS, that you should check the most up-to-date information available on your regional web or channel. If, for whatever reason, a part number change is made, it will not be noted in the printed Service Guide. For ACER-AUTHORIZED SERVICE PROVIDERS, your Acer office may have a DIFFERENT part number code to those given in the FRU list of this printed Service Guide. You MUST use the list provided by your regional Acer office to order FRU parts for repair and service of customer machines.

Chapter 1	System Specifications	1
	Features	1
	System Block Diagram	3
	Board Layout	4
	Top View	4
	Bottom View	5
	Outlook View	6
	Front View	6
	Left Panel	8
	Right Panel	9
	Rear Panel	10
	Bottom Panel	11
	Indicators	12
	Lock Keys	13
	Embedded Numeric Keypad	14
	Windows Keys	15
	Hot Keys	16
	Touchpad	18
	Touchpad Basics	18
	Hardware Specifications and Configurations	20
Chapter 2	System Utilities	31
	BIOS Setup Utility	31
	Navigating the BIOS Utility	31
	Multi-Boot Menu	32
	System Information	33
	Basic System Settings	34
	Startup Configuration	35
	System Security	37
	Load Default Settings	39
	BIOS Flash Utility	40
	System Utility Diskette	40
	System Diagnostic Diskette	40
	Running PQA Diagnostics Program	41
Chapter 3	Machine Disassembly and Replacement	43
	General Information	44
	Before You Begin	44
	Disassembly Procedure Flowchart	45
	Removing the Battery Pack	47
	Removing the Wireless LAN Module	48
	Removing the Hard Disk Drive Module	49
	Disassembling the Main Unit	50
	Removing the Middle Covers	50
	Removing the Keyboard	50
	Removing the LCD Module	51
	Removing the DIMM Upper Plate	53
	Removing the Internal Memory Module	53
	Removing the Modem Board	53
	Separating the Upper Case from the Lower Case	54
	Removing the RTC Battery	55
	Removing the Touch Pad Module	55
	Removing the Touch Pad FPC	56
	Removing the LCD Support Knobs	56

Table of Contents

Removing the System Board	57	
Removing the PCMCIA Socket	57	
Removing the VGA Plate	58	
Removing the Heat Sink Plate	58	
Removing the Modem Cable	59	
Disassembling the LCD Module	60	
Removing the LCD Bezel	60	
Removing the LCD Hinges with the Center Hinge	61	
Removing the Button Board & Inverter Board	61	
Removing the Main and Auxiliary Antenna	62	
Removing the LCD	62	
Removing the Coaxial Cable	63	
Removing the Sensor Board	63	
Chapter 4	Troubleshooting	65
System Check Procedures	66	
External Diskette Drive Check	66	
External CD-ROM Drive Check	66	
Keyboard or Auxiliary Input Device Check	67	
Memory Check	67	
Power System Check	67	
Touchpad Check	69	
Power-On Self-Test (POST) Error Message	70	
Index of Error Messages	71	
Index of Symptom-to-FRU Error Message	74	
Intermittent Problems	77	
Undetermined Problems	78	
Index of AFlash BIOS Error Message	79	
Index of PQA Diagnostic Error Code, Message	80	
Chapter 5	Jumper and Connector Locations	81
Top View	81	
SW2 Settings	82	
Bottom View	83	
Chapter 6	FRU (Field Replaceable Unit) List	85
Exploded Diagram	86	
Appendix A	Model Definition and Configuration	95
Appendix B	Test Compatible Components	97
Microsoft Windows XP Environment Test	98	
Appendix C	Online Support Information	101
Index		103

System Specifications

Features

This computer was designed with the user in mind. Here are just a few of its many features:

Performance

- Intel® low voltage Tualatin® processor up to 700MHz CPU with on-die 512K cache. CPU is lower power, fully static and with SMI feature.
- 64-bit memory bus
- AcerMedia bay (removable CD or DVD drive)
- High-capacity, Enhanced-IDE hard disk
- Li-Ion main battery pack
- Power management system with ACPI (Advanced Configuration Power Interface)

Display

- 10.4" Thin-Film Transistor (TFT) eXtended Graphics Array (XGA) liquid crystal-display (LCD)
- 3D capabilities
- Simultaneous LCD and CRT display support
- Supports other output display devices such as LCD projection panels for large-audience presentations
- "Automatic LCD dim" feature that automatically decides the best settings for your display and conserves power

Multimedia

- Built-in AC link audio subsystem which complies with the Microsoft PC 97/PC 98/ PC 99 specifications and meets WHQL audio requirements.
- Built-in one speaker
- High-speed optical drive (AcerMedia bay)
- External USB video capture kit option

Connectivity

- High-speed fax/data modem port
- Fast infrared wireless communication
- USB (Universal Serial Bus) ports
- Ethernet/Fast Ethernet port
- Optional InviLink 802.11b wireless LAN
- 1394 port
- One smart card slot

Expansion

- One type II CardBus PC Card slot
- Upgradeable memory
- DockMate V

Keyboard and Pointing Device

- 84-/85-key Windows keyboard
- Ergonomically-centered touchpad pointing device with scroll function

I/O Ports

- One type II CardBus PC Card slot
- One RJ-45 jack for Ethernet
- One RJ-11 phone jack
- One DC-in jack (AC adapter)
- One external monitor port
- One speaker/headphone-out jack
- One audio line-in jack
- One microphone-in jack
- Two USB ports
- One FIR port

System Block Diagram

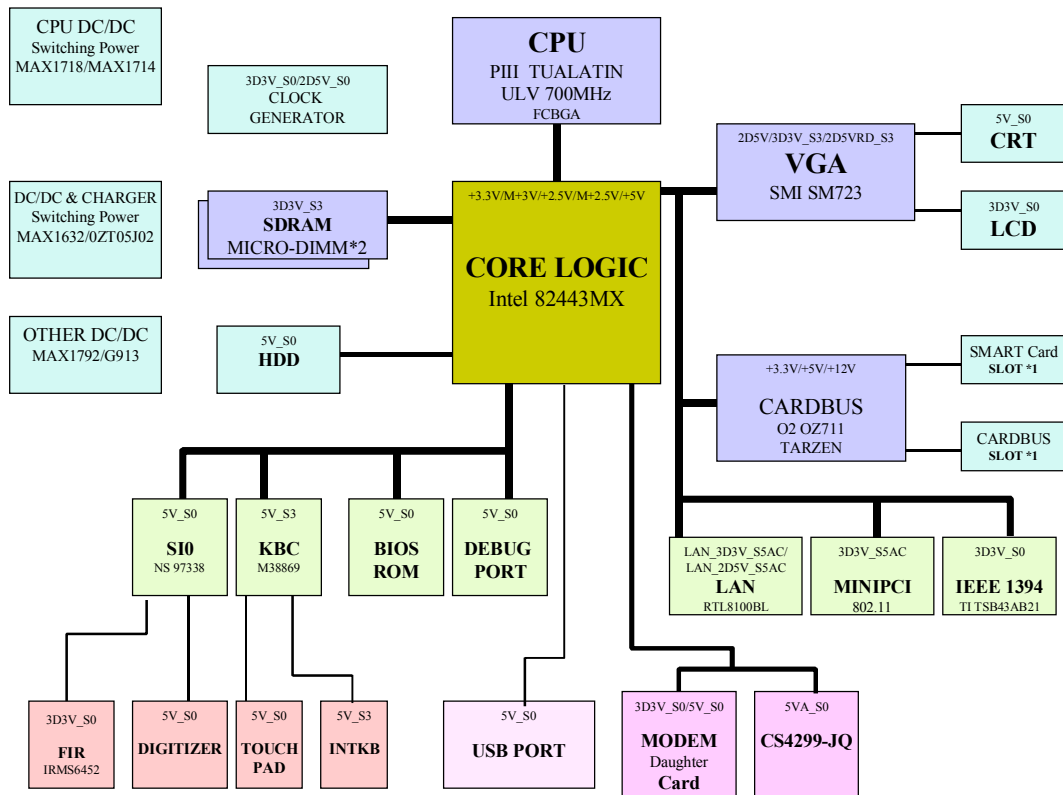

Board Layout

Top View

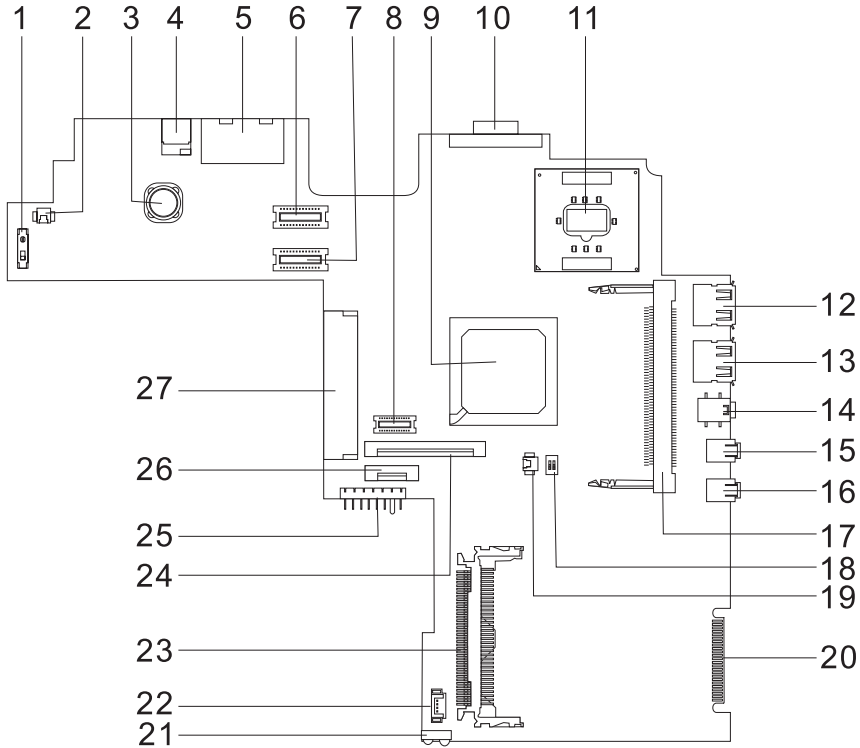

1	Power switch (SW1)	15	Line-in port
2	LCD cover switch connector	16	Line-out port
3	Choke (increase power consumption efficiency)	17	Memory slot 1
4	AC adapter connector	18	SW2 setting
5	RJ11 and RJ45 connectors	19	RTC battery connector
6	LCD coaxial cable connector	20	Debug purpose only
7	LED/Inverter board connector	21	FIR connector
8	Fax/Modem board connector	22	Internal microphone and tablet PC lid connector
9	Intel FW82443MX100 (Core Logic)	23	PCMCIA card connector
10	VGA port	24	Keyboard cable connector
11	CPU socket	25	Battery connector
12	USB port 1	26	Touchpad connector
13	USB port 2	27	Hard disk drive connector
14	1394 port		

Bottom View

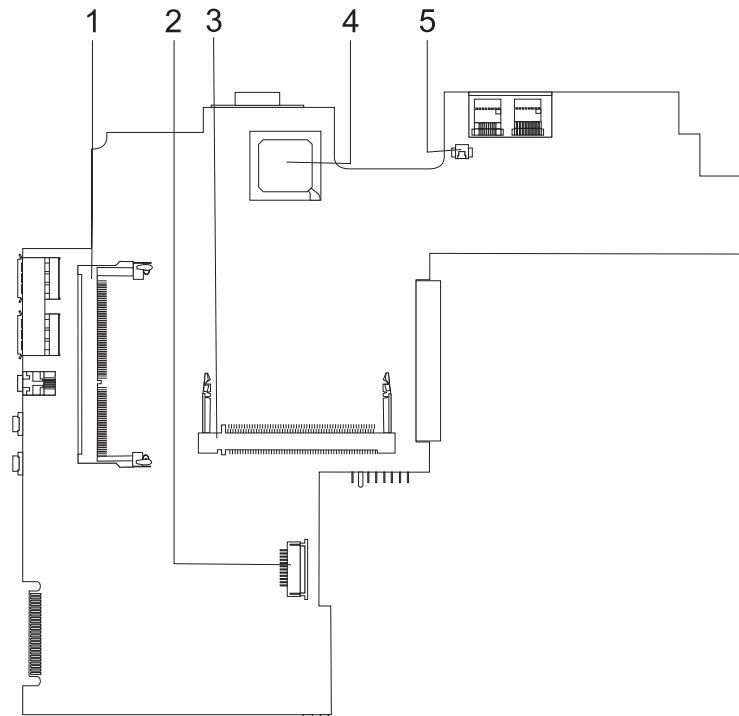

- | | | | |
|---|-----------------------------------|---|-------------------------------|
| 1 | Memory slot (DM2) | 4 | Lynx 3DM8+ (Video controller) |
| 2 | Smartcard connector | 5 | Modem cable connector |
| 3 | MiniPCI wireless module connector | | |

Outlook View

A general introduction of ports allow you to connect peripheral devices, as you would with a desktop PC.

Front View

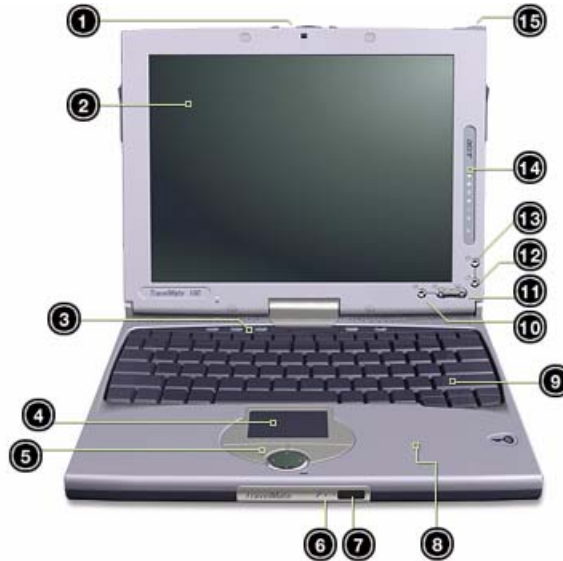

#	Item	Description
1	Latch	Use to latch the LCD screen in both normal mode and tablet mode.
2	Display screen	Also called LCD (liquid-crystal display), displays computer output. Touchscreen- capable with the aid of the Touchscreen-capable stylus.
3	Launch keys	Buttons for launching frequently used programs.
4	Touchpad	Touch-sensitive pointing device which functions like a computer mouse.
5	Click buttons (left, center and right)	The left and right buttons function like the left and right mouse buttons; the center button is a 4-direction scroll button.
6	Microphone	Captures sounds and voices into your computer.
7	Infrared port	Interfaces with infrared devices (e.g., infrared printer, IR-aware computer).
8	Palmrest	Comfortable support area for your hands when you use the computer.
9	Keyboard	Inputs data into your computer.
10	Enter button	Used to confirm selection in tablet mode.
11	Page up/Page down buttons	Used to scroll one page up or one page down in tablet mode.
12	Application key button	By default, used to invoke the Microsoft Notebook application.
13	ALT + ESC button	Used to cycle through active Windows application.

#	Item	Description
14	Status indicators	LEDs (light-emitting diode) that turn on and off to show the status of the computer, its functions and components.
15	Stylus	Used to input data in tablet mode.



Left Panel



#	Item	Description
1	Power switch	Turns on the computer power.
2	Hard disk bay	Houses the computer's hard disk (secured by a screw).

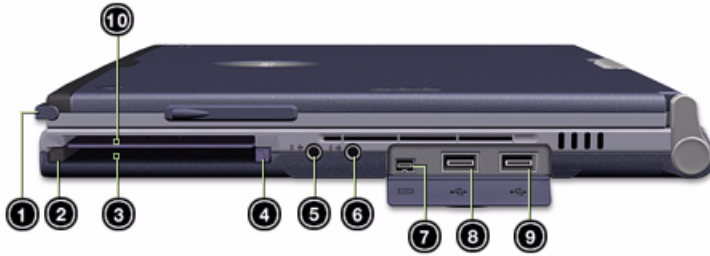



Right Panel

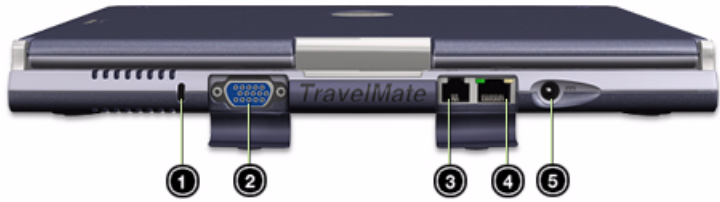

#	Item	Description
1	Stylus	For data input on the screen in tablet mode.
2	PC Card eject button	Ejects the PC Card from the slot.
3	PC Card slot 	Accepts one Type II 16-bit PC Card or 32-bit CardBus PC Card.
4	Smart Card eject button	Ejects the Smart Card from the slot.
5	Speaker/Headphone-out jack	Connects to audio line-out devices (e.g., speakers, headphones).
6	Line-in jack	Accepts audio line-in devices (e.g., audio CD player, stereo walkman).
7	IEEE 1394 port	Connects to IEEE 1394 devices.
8	USB 1 port 	Connects to any Universal Serial Bus devices (e.g., USB mouse, USB camera).
9	USB 2 port 	Connects to any Universal Serial Bus devices (e.g., USB mouse, USB camera).
10	Smart Card slot	Slot for Smart Card interface with pre-boot authentication system.

Rear Panel



#	Item	Description
1	Security keylock	Connects to a Kensington-compatible computer security lock.
2	External display port 	Connects to a display device (e.g., external monitor, LCD projector) and displays up to 1024x768 resolution.
3	Modem jack 	Connects to a phone line.
4	Network jack 	Connects to an Ethernet 10/100-based network
5	Power jack 	Connects to an AC adapter

Bottom Panel

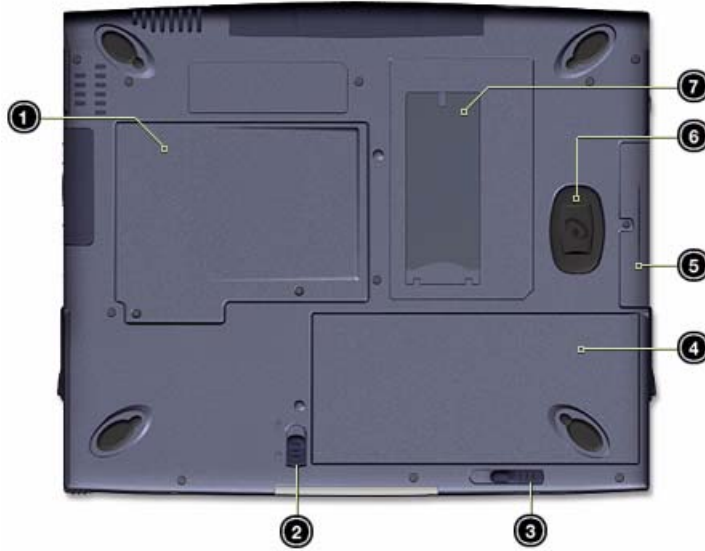







#	Item	Description
1	Memory compartment	Houses the computer's main memory.
2	Battery lock/unlock latch	Locks and unlocks the battery bay.
3	Battery release latch	Unlatches the battery to remove the battery pack.
4	Battery bay	Houses the computer's battery pack.
5	Hard disk bay	Houses the computer's hard disk (secured by a screw).
6	Hard disk anti-shock protection	Protects your hard disk against accidental shock and vibration.
7	Personal identification slot	Insert an identification card to personalize your computer.

Indicators

The computer has seven easy-to-read status icons on the right of the display screen.



The Power and Standby status icons are visible even when you close the display cover so you can see the status of the computer while the cover is closed.

Icon	Function	Description
	Num Lock	Lights when Num Lock is activated.
	Caps Lock	Lights when Caps Lock is activated.
	Battery Charge	Lights when the battery is being charged.
	Media Activity	Lights when the floppy drive, hard disk or optical drive is active.
	Sleep	Lights when the computer enters Sleep mode.
	Power	Lights when the computer is on.
	Wireless Communication	Lights when the Wireless LAN capabilities are enabled.

Lock Keys

The keyboard has three lock keys which you can toggle on and off.



Lock Key	Description
Caps Lock	When Caps Lock is on, all alphabetic characters typed are in uppercase.
Num Lock (Fn-F11)	When Num Lock is on, the embedded keypad is in numeric mode. The keys function as a calculator (complete with the arithmetic operators +, -, *, and /). Use this mode when you need to do a lot of numeric data entry. A better solution would be to connect an external keypad.
Scroll Lock (Fn-F12)	When Scroll Lock is on, the screen moves one line up or down when you press the up or down arrow keys respectively. Scroll Lock does not work with some applications.

NOTE: To access the Num Lock and Scroll Lock functions, hold the Fn key down while pressing the F11 and F12 keys respectively.

Embedded Numeric Keypad

The embedded numeric keypad functions like a desktop numeric keypad. It is indicated by small characters located on the upper right corner of the keycaps. To simplify the keyboard legend, cursor-control key symbols are not printed on the keys.











Desired Access	Num Lock On	Num Lock Off
Number keys on embedded keypad	Type numbers in a normal manner.	
Cursor-control keys on embedded keypad	Hold SHIFT while using cursor-control keys.	Hold Fn while using cursor-control keys.
Main keyboard keys	Hold Fn while typing letters on embedded keypad.	Type the letters in a normal manner.

NOTE: If an external keyboard or keypad is connected to the computer, the Num Lock feature automatically shifts from the internal keyboard to the external keyboard or keypad.

Windows Keys

The keyboard has two keys that perform Windows-specific functions.



Key	Description
Windows logo key 	Start button. Combinations with this key perform shortcut functions. Below are a few examples:  + Tab (Activates next taskbar button)  + E (Explores My Computer)  + F (Finds Document)  + M (Minimizes All)  +  + M (Undoes Minimize All)  + R (Displays the Run...dialog box)
Application key 	Opens a context menu (same as a right-click).



Hot Keys

The computer employs hot keys or key combinations to access most of the computer's controls like screen contrast and brightness, volume output and the BIOS Utility.

To activate hot keys, press and hold the **Fn** key before pressing the other key in the hot key combination.



Hot Key	Icon	Function	Description
Fn-F1	?	Hot key help	Displays help on hot keys.
Fn-F2		Setup	Accesses the notebook's configuration utility.
Fn-F3		Power Management Scheme Toggle	Switches the power management scheme used by the computer (function available if supported by operating system).
Fn-F4	Zz	Sleep	Puts the computer in Sleep mode.
Fn-F5		Display toggle	Switches display output between the display screen, external monitor (if connected) and both the display screen and external monitor.
Fn-F6		Screen blank	Turns the display screen backlight off to save power. Press any key to return.
Fn-F7		Touchpad toggle	Turns the internal touchpad on and off.
Fn-F8		Speaker toggle	Turns the speakers on and off.
Fn-		Volume up	Increases the speaker volume.
Fn-		Volume down	Decreases the speaker volume.
Fn-		Brightness up	Increases the screen brightness.

Hot Key	Icon	Function	Description
Fn- 		Brightness down	Decreases the screen brightness.

Touchpad

The built-in touchpad is a PS/2-compatible pointing device that senses movement on its surface. This means the cursor responds as you move your finger on the surface of the touchpad. The central location on the palmrest provides optimum comfort and support.

NOTE: When using an external USB or serial mouse, you can press Fn-F7 to disable the touchpad. If you are using an external PS/2 mouse, the touchpad is automatically disabled



Touchpad Basics

The following items teach you how to use the touchpad:

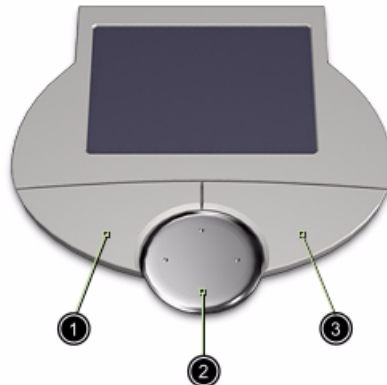

- Move your finger across the touchpad to move the cursor.
- Press the left (1) and right (3) buttons located on the edge of the touchpad to do selection and execution functions. These two buttons are similar to the left and right buttons on a mouse. Tapping on the touchpad produces similar results.
- Use the 4-way scroll (2) button (top/bottom/left and right) to scroll a page up, down, left or right. This button mimics your cursor pressing on the vertical and horizontal scroll bars of Windows applications.

Function	Left Button	Right Button	Center Buttons	Tap
Execute	Click twice quickly			Tap twice (at the same speed as double-clicking a mouse button)
Select	Click once			Tap once
Drag	Click and hold, then use finger to drag the cursor on the touchpad			Tap twice (at the same speed as double-clicking a mouse button) then hold finger to the touchpad on the second tap and drag the cursor
Access context menu		Click once		
Scroll			Click and hold the button in the desired direction (up/down/left/right)	

NOTE: Keep your fingers dry and clean when using the touchpad. Also keep the touchpad dry and clean. The touchpad is sensitive to finger movements. Hence, the lighter the touch, the better the response. Tapping harder will not increase the touchpad's responsiveness.

Hardware Specifications and Configurations

Processor

Item	Specification
CPU type	Intel® low voltage Tualatin® processor up to 700MHz CPU with on-die 512K cache
CPU package	FCBGA2 package
CPU core voltage	1.10V/0.95V/0.85V
CPU I/O voltage	1.25V

BIOS

Item	Specification
BIOS vendor	Acer
BIOS Version	V 3.3
BIOS ROM type	Flash ROM
BIOS ROM size	512KB
BIOS package	32-pin TSOP
Supported protocols	ACPI 1.0b, WfM 2.0, PC 2001, SM BIOS 2.3.1, IEEE 1394, IrDA V1.0, PCI 2.2, PnP BIOS 1.0a, Intel AC 97, USB specification 1.1, LDCM 6.0, PC card standard 1995 (PCMCIA V3.0 compliant device), Microsoft Simple Boot Flag specification 1.0 for ACPI OS, USB/1394 CDROM Boot Up support, Mini-PCI V1.0
BIOS password control	Set by switch, see SW2(SW1) setting

Second Level Cache

Item	Specification
Cache controller	Built-in CPU
Cache size	512KB for Pentium III
1st level cache control	Always enabled
2st level cache control	Always enabled
Cache scheme control	Fixed in write-back

System Memory

Item	Specification
Memory controller	Built-in Intel 443BX
Onboard memory size	0MB
DIMM socket number	2 sockets (2 banks)
Supports memory size per socket	64/128MB
Supports maximum memory size	256MB
Supports DIMM type	Synchronous DRAM
Supports DIMM Speed	133 MHz
Supports DIMM voltage	3.3V
Supports DIMM package	144-pin soDIMM
Memory module combinations	You can install memory modules in any combinations as long as they match the above specifications.

Memory Combinations

Slot 1	Slot 2	Total Memory
0 MB	64 MB	64 MB
64 MB	0 MB	64 MB
0 MB	128 MB	128 MB
64 MB	64 MB	128 MB
128 MB	0 MB	128 MB
64 MB	128 MB	192 MB
128 MB	64 MB	192 MB
128 MB	128 MB	256 MB

Above table lists some system memory configurations. You may combine DIMMs with various capacities to form other combinations.

NOTE: The shipping specification for DIMM combination is 64MB in slot 1.

LAN Interface

Item	Specification
Chipset	Realtek 8100BL
Supports LAN protocol	10/100 Mbps
LAN connector type	RJ45
LAN connector location	Rear side

Wireless LAN Interface

Item	Specification
Module	Lucent/ANC 64 bit AGERE W/RES
LAN interface	Mini PCI interface IEEE 802.11b LAN module
Channel support and default channel protocol	IEEE 802.11b
Enable/disable radio	Support FAA requirement

Modem Interface

Item	Specification
Module	Ambit T60M283/003L6 MDC
Fax modem data baud rate (bps)	14.4K
Data modem data baud rate (bps)	56K
Supports modem protocol	V.90 MDC
Modem connector type	RJ11
Modem connector location	Rear side

Floppy Disk Drive Interface

Item	Specification		
Vendor & model name	Y-E Data YD-8U10		
Floppy Disk Specifications			
Media recognition	2DD (720KB)	2HD (1.20MB, 3-mode)	2HD (1.44MB)
Sectors/track	9	15	18
Tracks	80	80	80

Floppy Disk Drive Interface

Item	Specification		
Data transfer rate (Kbit/s)	250 KBit/Sec	500 KBit/Sec	500 KBit/Sec
Rotational speed (RPM)	300	360	300
Read/write heads	2		
Encoding method	MFM		
Power Requirement			
Power voltage (Vcc)	DC 4.40V to 5.25V		

Hard Disk Drive Interface

Item	Specification		
Vendor & Model Name	IBM Travelstar DJSA-210	IBM Travelstar DJSA-220	IBM Travelstar DJSA-230
Capacity	10G	20G	30G
Bytes per sector	512	512	512
Data heads	2	4	6
Recording zone	16	16	16
Drive Format			
Disks	1	2	3
Spindle speed (RPM)	4200 RPM	4200 RPM	4200 RPM
Performance Specifications			
Buffer size	384KB	1874KB	1874KB
Interface	ATA-5	ATA-5	ATA-5
Data transfer rate (buffer to/ from media, Mbytes/s)	109 ~ 203	109 ~ 203	109 ~ 203
Interface transfer rate (host-buffer, Mbytes/s)	66 MB/Sec. Ultra DMA mode 66	66 MB/Sec. Ultra DMA mode 66	66 MB/Sec. Ultra DMA mode 66
DC Power Requirements			
Voltage tolerance	5V(DC) +/- 5%	5V(DC) +/- 5%	5V(DC) +/- 5%

CD-ROM (6X) Interface

Item	Specification
Vendor & model Name	AOpen SC-924U
Performance specification	With CD Diskette
Transfer rate (KB/sec)	Sustained: Max 900KBytes/sec
Disc data capacity	12cm Disc: 540MBytes (Mode 1), 630MBytes (Mode 2) 8cm Disc: 180MBytes (Mode 1), 210MBytes (Mode 2)
Interface	USB1.1
Applicable disc format	CD-DA, CD-ROM (Mode 1 and Mode 2), CD-ROM/XA (Mode 2, Form 1 and Form 2), CD-Extra, CD-I, Video CD, Photo CD (Single and Multiple Sessions), I-Trax, CD-R, CD-RW
Operating system	Windows 98SE, Windows NT, Windows ME, Windows 2000, Windows XP
Power requirement	
Input voltage	5V(DC) +/- 5%

Audio Interface

Item	Specification
Audio Controller	CS4299-JQ
Audio onboard or optional	Built-in
Mono or Stereo	Stereo
Resolution	20 bit stereo Digital to analog converter 18 bit stereo Analog to Digital converter
Compatibility	Microsoft PC98/PC99, AC97 2.1
Mixed sound source	Line-in, CD, Video, AUX
Voice channel	8/16-bit, mono/stereo
Sampling rate	44.1 KHz
Internal microphone	Yes
Internal speaker / Quantity	Yes

Video Interface

Item	Specification
Chip vendor	SMI
Chip name	Lynx 3DM+
Chip voltage	Core/2.5V Memory/2.5V
Supports ZV (Zoomed Video) port	No
Graph interface	PCI
Maximum resolution (LCD)	1024x768 (16 bit and 24 bit colors)
Maximum resolution (CRT)	2048x768 (16 bit colors)

Video Memory

Item	Specification
Fixed or upgradeable	Fixed
Video memory size	8 MB

Video Resolutions Mode (for both LCD and CRT)

Resolution	8 bits (256 colors)	16 bits (High color)	24 bits (True color)
640x480	Yes	Yes	Yes
720x480	Yes	Yes	Yes
800x600	Yes	Yes	Yes
848x480	Yes	Yes	Yes
1024x768	Yes	Yes	Yes
1280x1024 (CRT only)	Yes	Yes	Yes
2048x768 (CRT only)	Yes	Yes	No

USB Port

Item	Specification
USB Compliancy Level	1.1
OHCI	USB 1.1
Number of USB port	2
Location	Right side
Serial port function control	Enable/Disable by BIOS Setup

IrDA Port

Item	Specification
IrDA FIR port controller	NS PL97338
Number of IrDA FIR port	1
Location	Front side
IrDA FIR port function control	Enable/disable by BIOS Setup
IrDA FIR port (in BIOS Setup)	2F8
IrDA FIR port IRQ (in BIOS Setup)	IRQ3
ECP DMA channel (in BIOS Setup)	DMA channel 3
Optional IrDA FIR port DRQ (in BIOS Setup)	Not available

PCMCIA Port

Item	Specification
PCMCIA controller	O2 OZ711
Supports card type	Type-II
Number of slots	One type-II
Access location	Left side
Supports ZV (Zoomed Video) port	ZV support
Supports 32 bit CardBus	Yes (IRQ10, IRQ15)

System Board Major Chips

Item	Controller
System core logic	Intel 443BX / PIIX4E
Super I/O controller	NS PL97338
Audio controller	CS4299-JQ
Video controller	SMI Lynx 3DM+
Hard disk drive controller	Intel PIIX4E
Keyboard controller	M38867
RTC	Built-in Intel 443BX / PIIX4E

Keyboard

Item	Specification
Keyboard controller	Mitsubishi M38869
Keyboard vendor & model name	Darfon A5001 (84) / A500G (85) / A500J (88)
Total number of keypads	84/85/88-key

Keyboard

Item	Specification
Windows 95 keys	Yes
Internal & external keyboard work simultaneously	Yes

Battery

Item	Specification
Vendor & model name	Sanyo 4UF103450P-1
Battery Type	Li-ion
Pack capacity	1800 mAh
Cell voltage	Over charge protection: Charge FET turns off if any cell voltage is 4.35V +/- 0.05V or over Over discharge protection: Discharge FET turns off when any cell voltage is less than 2.5V
Number of battery cell	4
Package configuration	1 row with 4 cells
Package voltage	14.8 V

DC-AC LCD Inverter

Item	Specification
Vendor & model name	Ambit T621194.00
Input supply voltage (V)	LCDBATOUT 8.5V ~ 21V
Input signal voltage	Front Panel Back: 2.0 ~ 3.6V=ON, -0.3 ~ 0.8=OFF#
Output current (mA)	Min.: 0.6 +/- 0.6 (mA) Max.: 6 +/- 0.5 (mA)
Environmental Specifications	
Ambient operating temperature	0 ~ 50 degree C
Ambient operating humidity	10% ~ 90%
Storage temperature	-20 ~ 60 degree C
Storage humidity	10% ~ 90%

NOTE: DC-AC inverter is used to generate very high AC voltage, then support to LCD CCFT backlight user, and is also responsible for the control of LCD brightness. Avoid touching the DC-AC inverter area while the system unit is turned on.

NOTE: There is an EEPROM in the inverter, which stores its supported LCD type and ID code. If you replace a new inverter or replace the LCD with a different brand, use Inverter ID utility to update the ID information.

LCD

Item	Specification
Vendor & model name	Toshiba LTM10C321K
Mechanical Specifications	
LCD display area (diagonal, inch)	10.4
Display technology	TFT
Resolution	XGA (1024x768)
Supports colors	256K

LCD

Item	Specification
Optical Specification	
Brightness control	keyboard hotkey
Contrast control	No
Recommended Operating Conditions	
Supply voltage for LCD display (V)	3.0 ~ 3.6 V
Fluorescent lamp driving voltage (Vrms)	540 ~ 640 V(rms)

Electronic Stylus

Item	Specification
Vendor	WACOM
Model number	MP-200-00
Maximum pressure	Tip switch: 1Kg or less Side switch: 300g or less
Weight	Approximately 8g
Environmental Specification	
Operating temperature	+5 ~ +40
Storage temperature	-10 ~ +60
Operating humidity	+20 ~ +80% (no condensation)
Storage humidity	+20 ~ +80% (no condensation)

Digitizer Unit

Item	Specification
Vendor	WACOM
Model number	SU-001-01
Supply voltage	-0.3 ~ +4.0 V
Input voltage of signals	-0.3 ~ Supply voltage +0.3 V
High level output current	-5 mA
Low level output current	-10 mA
Weight	Approximately 47.5g
Environmental Specification	
Operating ambient temperature	0 ~ +60
Storage temperature	-10 ~ +70
Operating ambient humidity	+20 ~ +80% (no condensation)
Storage humidity	+20 ~ +90% (no condensation)

AC/DC Adapter

Item	Specification
Vendor & model name	LITE-ON PA-1500-02
Input Requirements	
Maximum input current (A, @90Vac, full load)	The maximum input current shall be less than 1.0 Ampere at 50W load and 100Vac input voltage.
Nominal input frequency	50 ~ 60 Hz
Input frequency variation range	47 ~ 63 Hz

AC/DC Adapter

Item	Specification
Nominal input voltages	100 ~ 240 Vac
Input voltage variation range	90 ~ 270 Vac
Inrush current	Input Voltage: 100Vac, Inrush Current: 50A maximum Input Voltage: 240Vac, Inrush Current: 100A maximum
Efficiency	The adapter efficiency shall be capable to meet the case temperature rising requirement, above 85% is needed.
Output Ratings (CV mode)	
DC output voltage	+19.5V ~ 21.0V
Noise + Ripple	250mvp-pmax
Load	0 A (min.) 2.5 A (max.)
Output Ratings (CC mode)	
Constant output	3.0 ± 0.3 A
Dynamic Output Characteristics	
Turn-on delay time	3 sec.
Hold up time	8 ms
Over Voltage Protection (OVP)	25 V
Short circuit protection	Shall be capable of withstanding a continuous short-circuit to DC output without damage or overstress to the component, PCB traces and connector under the AC input conditions specified above.
Electrostatic discharge (ESD)	+/-4KV (at air discharge, no allowed errors.) +/-8KV (at air discharge, restart & damage errors are not allowed) +/-15KV (at air discharge, restart & damage errors are not allowed) +/-4KV (at contact discharge, no allowed errors.) +/-6KV (at contact discharge, restart & damage errors are not allowed) +/-8KV (at contact discharge, restart & damage errors are not allowed)
Dielectric Withstand Voltage	
Primary to secondary	The adapter shall withstand for 1 minute without breakdown the application of a 60Hz 3000Vac supply voltage applied between both input line and output (10mA DC cut-off current).
Leakage current	0.25 mA max. (@ 254 Vac, 60Hz)
Regulatory requirements	Shall meet: 1. FCC CFR47 Part 15 class B requirements. (USA) 2. VFG 243 class B requirements. (Germany) 3. CISPR 22 Class B requirements. (Scandinavia) 4. VCCI class II requirements. (Japan)

Power Management

Power Saving Mode	Phenomenon
Standby Mode Waiting time specified by the System Standby value or the operating system elapses without any system activity. Or When the computer is about to enter Hibernation mode (e.g., during a battery-low condition), but the Hibernation file is invalid or not present.	<input type="checkbox"/> The Sleep indicator lights up

Power Management

Power Saving Mode	Phenomenon
Hibernation Mode When customized functions for power management are set to Hibernation and the corresponding action is taken.	<input type="checkbox"/> All power shuts off
Display Standby Mode Keyboard, built-in touchpad, and an external PS/2 pointing device are idle for a specified period.	<input type="checkbox"/> The display shuts off
Hard Disk Standby Mode Hard disk is idle within a specified period of time.	<input type="checkbox"/> Hard disk drive is in standby mode. (spindle turned-off)

Environmental Requirements

Item	Specification
Temperature	
Operating	+5 ~ +35 °C
Non-operating	-10 ~ +60 °C
Non-operating	-20 ~ +60 °C (storage package)
Humidity	
Operating	20% to 80% RH, non-condensing
Non-operating	20% to 90% RH, non-condensing (unpacked)
Non-operating	20% to 90% RH, non-condensing (storage package)
Vibration	
Operating (unpacked)	5 ~ 25.6Hz: 0.38mm (peak to peak) 25.6 ~ 250Hz: 0.5G
Non-operating (unpacked)	5 ~ 27.1Hz: 0.6G 27.1Hz ~ 50Hz: 0.4mm (peak to peak) 50 ~ 500Hz: 2.0G
Non-operating (packed)	5 ~ 62.6Hz: 0.51mm (peak to peak) 62.6 ~ 500Hz: 4G

Mechanical Specification

Item	Specification
Dimensions	251 (W) x 205 (D) x 25.7/29.7 (H)
Weight	3.1 lbs
I/O Ports	1 type II CardBus socket, 1 RJ-11 modem port, 1 RJ-45 LAN port, 1 DC-in jack (AC adapter), 1 FIR port, 1 external monitor port, 2 USB ports, 1 audio line-out/headphone-out jack, 1 audio line-in/microphone-in jack
Drive Bays	None
Material	Housing: MCS-050 Panel : Plastic
Indicators	Num Lock, Caps Lock, Battery Charge, Media Activity, Sleep LED, Power LED, Wireless Communication
Switch	Power

Memory Address Map

Memory Address	Size	Function
00100000h-000F0000h	64 KB	System BIOS
000F0000h-000E0000h	64 KB	UMB Area
000E0000h-000C0000h	128 KB	VGA BIOS
000C0000h-000A0000h	128 KB	Video memory (VRAM)
000A0000h-00000000h	640 KB	Conventional memory

I/O Address Map

I/O Address	Function
0000-000F	Direct memory access controller
0000-0CF7	PCI bus
0020-0021	Programmable interrupt controller
0040-0043	System timer
0060-0060	Standard 101/102-key or Microsoft natural PS/2 keyboard
0061-0061	System speaker
0062-0062	Microsoft ACPI-compliant embedded controller
0064-0064	Standard 101/102-key or Microsoft natural PS/2 keyboard
0066-0066	Microsoft ACPI-compliant embedded controller
0070-0073	System CMOS/real time clock
0080-0080	Motherboard resources
0081-008F	Direct memory access controller
0092-0092	Motherboard resources
00A0-00A1	Programmable interrupt controller
00B0-00B3	Motherboard resources
00C0-00DF	Direct memory access controller
00F0-00FF	Numeric data processor
01F0-01F7	Primary IDE channel
0274-0277	ISAPNP Read Data Port
0279-0279	ISAPNP Read Data Port
02C8-02CF	Motherboard resources
02F8-02FF	Acer Laptop Fast Infrared port
03B0-03BB	Silicon Motion Lynx3DM
03C0-03DF	Silicon Motion Lynx3DM
03F6-03F6	Primary IDE channel
03F8-03FF	Wacom Serial Pen HID Tablet
0460-0463	Tablet PC Buttons
04D0-04D1	Motherboard resources
0A79-0A79	ISAPNP Read Data Port
0D00-FFFF	PCI bus
7000-70FF	Avance AC'97 Audio for Intel (R) Audio Controller
7400-743F	Avance AC'97 Audio for Intel (R) Audio Controller
7800-78FF	Lucent Technologies Soft Modem AMR
7C00-7C7F	Lucent Technologies Soft Modem AMR
8000-80FF	Realtek RTL 8139 Family PCI Fast Ethernet NIC
8400-841F	Intel (R) 82440MX USB Universal Host Controller

I/O Address Map

I/O Address	Function
8440-844F	Intel (R) 82440MX Bus Master IDE Controller
F000-F03F	Motherboard resources
F100-F10F	Motherboard resources
FB00-FBFE	O2 Micro Smart Card Bus Reader
FC00-FCFF	O2 Micro Card Bus Controller
FD00-FDFF	O2 Micro Card Bus Controller
FE00-FEFF	O2 Micro Card Bus Controller
FF00-FFFF	O2 Micro Card Bus Controller

IRQ Assignment Map

Interrupt Channel	Function
IRQ0	System timer
IRQ1	Keyboard
IRQ2	Cascade
IRQ3	FIR (Serial port)
IRQ4	COM1 (Serial port) for Digitizer
IRQ5	Reserved
IRQ6	Reserved for R2 card
IRQ7	Reserved
IRQ8	CMOS/RTC
IRQ9	SCI IRQ used by ACPI bus
IRQ10	VGA (PIRQA#), USB (PIRQD#), OZ711 CardBus (PIRQA#)
IRQ11	AC'97 Audio (PIRQB#), AC'97 Modem (PIRQB#)
IRQ12	PS/2 device
IRQ13	Math processor
IRQ14	IDE primary channel
IRQ15	LAN (PIRQC#), IEEE 1394 (PIRQC#), 802.11b (PIRQC#)

DMA Channel Assignment

DMA Channel	Function
DRQ0	Reserved
DRQ1	FIR controller
DRQ2	Reserved
DRQ3	Reserved
DRQ4	DMA controller
DRQ5	Reserved
DRQ6	Reserved
DRQ7	Reserved

System Utilities

BIOS Setup Utility

The BIOS Setup Utility is a hardware configuration program built into your computer's BIOS (Basic Input/Output System).

Your computer is already properly configured and optimized, and you do not need to run this utility. However, if you encounter configuration problems, you may need to run Setup. Please also refer to Chapter 4 Troubleshooting when problem arises.

To activate the BIOS Utility, press **F2** during POST (while the TravelMate logo is being displayed).

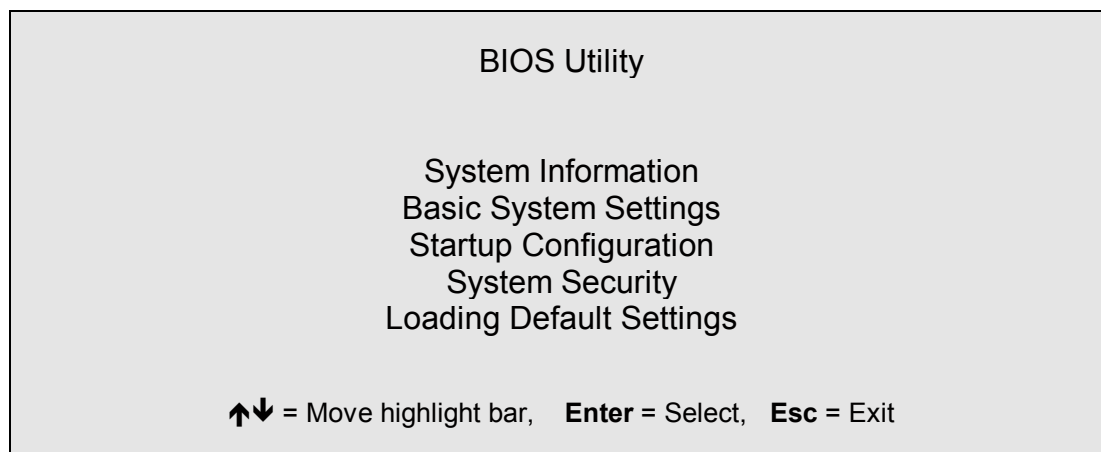

Navigating the BIOS Utility

There are six menu options: System Information, Basic System Settings, Startup Configuration, System Security and Loading Default Settings.

To enter a menu, highlight the item using the **↑** / **↓** keys, then press **ENTER**.

Within a menu, navigate through the BIOS Utility by following these instructions:

- Press the **↑** / **↓** keys to move between the parameters.
- Press the **←** / **→** keys to change the value of a parameter.
- Press the **Esc** key while you are in any of the menu options to return to the main menu.

NOTE: You can change the value of a parameter if it is enclosed in square brackets. Navigation keys are shown at the bottom of the screen.

Multi-Boot Menu

Users can press F12 during POST to enter the Multi Boot Selection Menu. In this menu users can change boot device without entering BIOS SETUP utility.

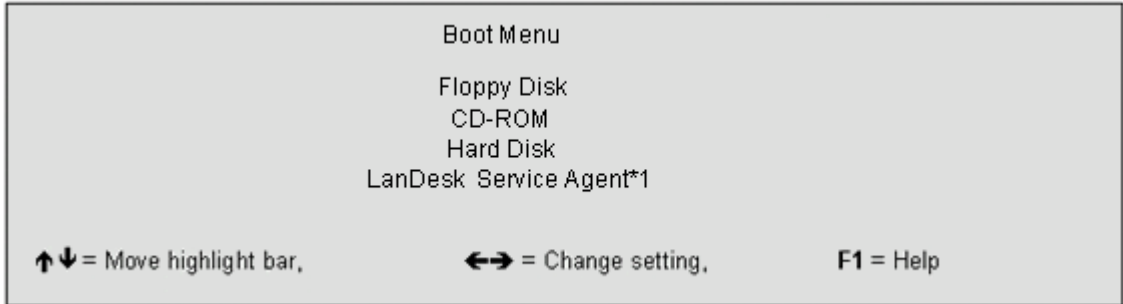

NOTE: If users disable the "Boot from LAN" option in BIOS SETUP utility, then the option of Lan Desk Service Agent will not appear.

System Information

The System Information screen displays a summary of your computer hardware information.

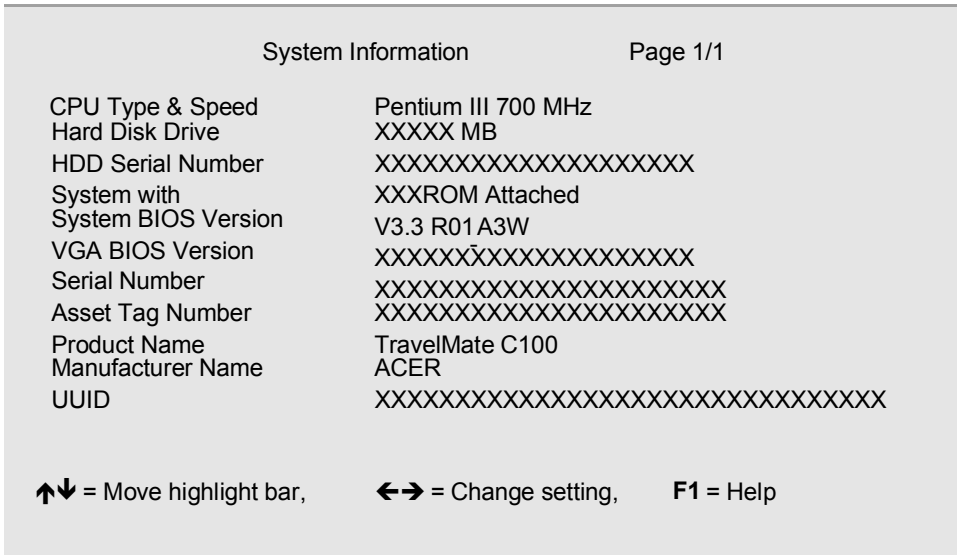

NOTE: The screen above is a sample and may not reflect the actual data on your computer. "X" may refer to a series of numbers and/or characters.

The following table describes the information in this screen.

Parameter	Description
CPU Type & Speed	Display the CPU type and its speed.
Hard Disk Drive	Display the size of the Hard Disk.
HDD Serial Number	List the HDD serial Number
System with	The system will automatically detect that the media type is CD-ROM, DVD-ROM.
System BIOS Version	The current system BIOS version.
VGA BIOS Version	The current VGA BIOS version.
Serial Number	Shows the system serial number.
Asset Tag Number	Shows the asset tag number of the computer.
Product Name	Shows the official name of the product.
Manufacturer Name	Shows the manufacturer of the computer.
UUID	Shows the universally unique identifier of your computer.

The items in this screen are important and vital information about your computer. If you experience computer problems and need to contact technical support, this data helps our service personnel know more about your computer.

Basic System Settings

The Basic System Settings screen allows you to set the system date and time.

Basic System Setting page 1/1

Date	[Mon Jan 1, 2001]
Time	[12:00:00]

↑↓ = Move highlight bar, ↔ = Change setting, F1 = Help

The following table describes the parameters in this screen.

Parameter	Description	Format
Date	Sets the system date.	DDD MMM DD, YYYY (day-of-the-week month day, year)
Time	Sets the system time.	HH:MM:SS (hour:minute:second)

Startup Configuration

The Startup Configuration screen contains parameter values that define how your computer behaves on system startup.

The following table describes the parameters in this screen. Settings in **boldface** are the default and suggested parameter settings.

Startup Configuration		Page 1/1
Boot Display	[Both] / [Auto]	
Screen Expansion	[Enabled] / [Disabled]	
Auto Dim Function	[Enabled] / [Disabled]	
Resume On LAN/Modem Access	[Enabled] / [Disabled]	
Hotkey Beep	[Enabled] / [Disabled]	
Fast Boot	[Enabled] / [Disabled]	
Network Device	[Ethernet] / [Wireless]	
Boot on LAN	[Enabled] / [Disabled]	
1394 Legacy Mode	[Enabled] / [Disabled]	
Boot Drive Sequence		
1	[Floppy]	
2nd	[CD-ROM]	
3 rd	[Hard Disk]	
4 th	[LANDesk ® Service Agent]	
Intel® SpeedStep™ Technology	[Automatic] / [Maximum Performance] / [Battery Optimized]	
↑↓ = Move highlight bar, ←→ = Change setting, F1 = Help		

The following table describes the parameters in this screen. Settings in **boldface** are the default and suggested parameter settings

Parameter	Description	Options
Boot Display	Sets the display device on boot-up. When set to Auto, the computer automatically determines the display device. If an external display device (eg. monitor) is connected, it becomes the boot display. When set to Both, the computer outputs to both the LCD and the external display if one is connected.	Both or Auto
Screen Expansion	Expand the screen on the graphic/text mode. When it is disabled, the graphic/text mode expansion function is disabled and the graphic/text image will be centralized on the LCD. If it is enabled, the graphic/text image will be expanded to the full LCD screen.	Enabled or Disabled
Auto Dim Function	When enabled, the system supports an automatic dimming of the LCD back light, when the AC power source is not available.	Enabled or Disabled
Resume on LAN/Modem Access	When enabled, the computer will wake up from sleep state if any LAN access to it occurs.	Enabled or Disabled

The following table describes the parameters in this screen. Settings in **boldface** are the default and suggested parameter settings

Parameter	Description	Options
Hotkey Beep	When enabled, the computer makes a beep when a hot key (Fn+F4) is pressed.	Enabled or Disabled
Fast Boot	When this flag is set, the ACPI OS will communicate with the BIOS to decide the next POST is Fast or Diagnostic.	Enabled or Disabled
Network Device	When the Ethernet is selected, the on-board 10/100 LAN device will be enabled and wireless LAN will be disabled, vice versa. If the wireless LAN device is not installed, this option will be gray and show ethernet.	Ethernet or Wireless
Boot on LAN	When enabled, remote host with appropriate boot image can boot this computer. (Only work with Ethernet device.)	Disabled or Enabled
1394 Legacy Mode	When this item is enabled, it can support boot from 1394 DVD or HDD.)	Enabled or Disabled
Boot Drive Sequence Floppy Disk Drive CD-ROM Hard Disk 4th: LANDesk [®] Service Agent 5th:-----	<p>Specifies the order in which the computer starts up from. Please refer to below section.</p> <p>Enables boot-up from the floppy drive, if selected as the first option. The computer attempts to boot from the floppy disk drive (looks for a bootable floppy) before following the boot sequence specified in the Boot Drive Sequence.</p> <p>Enables boot-up from the optical drive, if selected as the first option. The computer attempts to boot from the CD (looks for a bootable CD) before following the boot sequence specified in the Boot Drive Sequence.</p> <p>Enables boot-up from the hard disk.</p> <p>Boot on LAN disabled.</p> <p>With 1394 device installed and 1394 Legacy Mode enabled, this option will pop up. The name for this option varies, depending on the decision by the Device Team.</p>	1st: Floppy Disk 2nd: CD-ROM 3rd: Hard Disk 4th: LANDesk [®] Service Agent 5th: -----
Intel [®] SpeedStep [™] Technology	There are three CPU speeds available for users to specify the CPU speed.	Automatic Maximum Performance Battery Optimized

Setting the Boot Drive Sequence

The Boot Drive Sequence section lists boot priorities (1st, 2nd, 3rd and 4th, 5th-see the explanation above) for bootable drives in your computer.

For example, the default value (1st: Floppy Disk, 2nd: CD-ROM, 3rd: Hard Disk) tells the computer to first search for a bootable floppy disk in the floppy drive. If it finds one present, it boots up from that floppy disk. If not, the computer continues to search for a bootable CD-ROM in the CD-ROM drive. If it cannot boot up from the CD-ROM drive, it continues by booting up from the hard disk.

To set the boot drive sequence, use the **↑** / **↓** keys to select a priority level (1st, 2nd, 3rd, 4th and 5th), then use the **←** / **→** keys to select the device for that priority level.

System Security

The System Security screen contains parameters that help safeguard and protect your computer from unauthorized use.

System Security
Page 1/1

Setup Password	[None]/[Present]
Power On Password	[None]/[Present]
Hard Disk Password	[None]/[Present]
Processor Serial Number	[Enabled] / [Disabled]



↑↓ = Move highlight bar,
↔ = Change setting,
F1 = Help

The following table describes the parameters in this screen. Settings in **boldface** are the default and suggested parameter settings.

Parameter	Description	Options
Setup Password	When set, this password protects the computer and the BIOS Utility from unauthorized entry. See the following section for instructions on how to set a password.	None or Present
Power On Password	When set, this password protects the computer from unauthorized entry. See the following section for instructions on how to set a password.	None or Present
Hard Disk Password	This item appears only if the platform is business model.	None or Present
Processor Serial Number	A lot of literature available on the serial number suggests that it should be used to encrypt and decrypt data sent to and from e-commerce sites.	Enabled or Disabled

Setting a Password



Follow these steps:

1. Use the cursor up/down keys to highlight a Password parameter (Setup, Power-on, Hard Disk, or Resume) and press the  /  key. The password box appears:



2. Type a password. The password may consist of up to eight characters (A-Z, a-z, 0-9).

IMPORTANT: Be very careful when typing your password because the characters do not appear on the screen.

3. Press . Retype the password to verify your first entry and press .
4. After setting the password, the computer automatically sets the chosen password parameter to Present.

Four password types protect your computer from unauthorized access. Setting these passwords creates several different levels of protection for your computer and data:

- Setup Password prevents unauthorized entry to the BIOS Utility. Once set, you must key-in this password to gain access to the BIOS Utility.
- Power-On Password secures your computer against unauthorized use. Combine the use of this password with password checkpoints on boot-up and resume from hibernation for maximum security.
- Hard Disk Password protects your data by preventing unauthorized access to your hard disk. Even if the hard disk is removed from the computer and moved to another computer, it cannot be accessed without the Hard Disk Password.

When a password is set, a password prompt appears on the left-hand corner of the display screen.



1. When the Setup Password is set, the following prompt appears when you press  to enter the BIOS Utility at boot-up.

Setup Password

Type the Setup Password and press  to access the BIOS Utility.



2. When the Power On Password is set, the following prompt appears at boot-up.



Type the Power On Password (a symbol appears for each character you type) and press  to use the computer. If you enter the password incorrectly, an **x** symbol appears. Try again and press .

3. When the Hard Disk Password is set, the following prompt appears at boot-up.



Type the Hard Disk Password (a symbol appears for each character you type) and press  to use the computer. If you enter the password incorrectly, an **x** symbol appears. Try again and press .

You have three chances to enter a password. If you successfully entered the password, the system starts Windows.

If you fail to enter the password correctly after three tries, the system hangs.

To change a password, follow the same steps used to set a password.

To remove a password, follow the same steps used to set a password, except type nothing in the password boxes.

Load Default Settings

If you want to restore all parameter settings to their default values, select this menu item and press **ENTER**. The following dialog box displays.

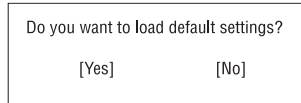

Do you want to load default settings?

[Yes] [No]

If you would like to load default settings for all parameters, use the cursor **←** / **→** keys to select **Yes**; then press **ENTER**. Choose **No** if otherwise.

BIOS Flash Utility

The BIOS flash memory update is required for the following conditions:

- New versions of system programs
- New features or options

Use the IFlash utility to update the system BIOS flash ROM.

NOTE: Do not install memory-related drivers (XMS, EMS, DPMI) when you use IFlash.

NOTE: This program contains a readme.txt file. This readme.txt file will introduce on how to use IFlash utility.

System Utility Diskette

This utility diskette is for the Acer TravelMate C100 notebook machine. You can find the utility in Service CD kit. It provides the following functions:

1. Panel ID Utility
2. Thermal Utility
3. Mother Board Data Utility

To use this diskette, first boot from this diskette, then a "Microsoft Windows ME Startup Menu" prompt you to choose the testing item. Follow the instructions on screen to proceed.

NOTE: This program contains a readme.txt file. This readme.txt file will introduce each test utility and its functions.

System Diagnostic Diskette

IMPORTANT: ¹The diagnostics program here that we used is called PQA (Product Quality Assurance) and is provided by Acer Headquarters. You can utilize it as a basic diagnostic tool. To get this program, either download it from <http://csd.acer.com.tw> or find it in the TravelMate C100 service CD kit. To better fit local service requirements, your regional office MAY have other diagnostic program. Please contact your regional offices or the responsible personnel/channel to provide you with further technical details.

NOTE: This program contains a readme.txt file. This readme.txt file will introduce each test and its functions.

¹ New added description. Please pay attention to it.

Running PQA Diagnostics Program

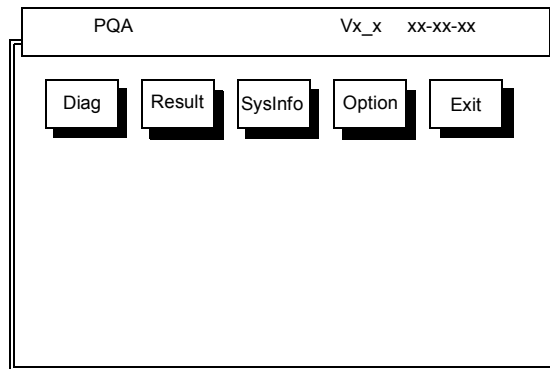

Press **←** / **→** to move around the main menu. Press **ENTER** to enable the selected option. The main options are Diag, Result, SysInfo, Option and Exit.

The Diag option lets you select testing items and times.

The following screen appears when you select Diag from the main menu.

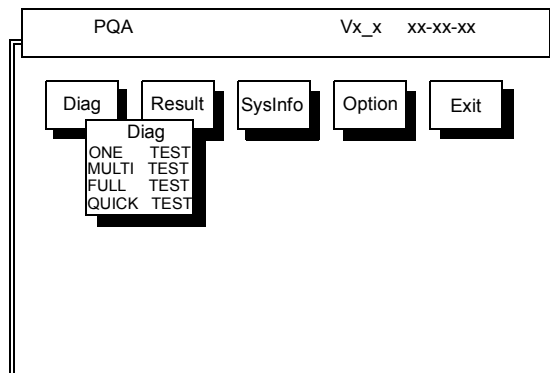

One Test performs a single test and Manual checks the selected test items in sequence.

Multi Test performs multiple tests of the selected items and check the selected test items in sequence.

Full Test performs all test items in detail for your system.

Quick Test performs all test items quickly for your system.

The screen below appears if you select Multi Test.

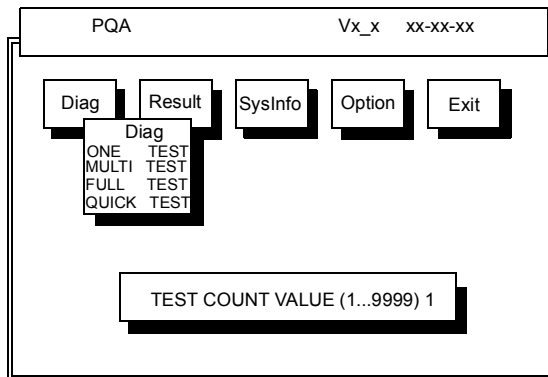

Specify the desired number of tests and press **ENTER**.

After you specify the number of tests to perform, the screen shows a list of test items (see below).

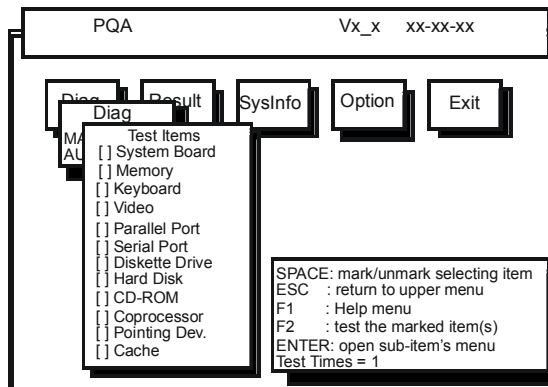

Move the highlight bar from one item to another. Press Space to enable or disable the item. Press **ENTER** to view the available options of each selected item. Press **ESC** to close the submenu.

The right corner screen information gives you the available function keys and the specified test number.

- Space: Enables/disables the item
- ESC: Exits the program
- F1: Help
- F2: Tests the selected item(s)
- Enter: Opens the available options
- Test Times: Indicates the number of tests to perform.

NOTE: The F1 and F2 keys function only after you finish configuring the Test option.

NOTE: When any errors are detected by diagnostic program, refer to "Index of PQA Diagnostic Error Code" for troubleshooting.

Machine Disassembly and Replacement

This chapter contains step-by-step procedures on how to disassemble the notebook computer for maintenance and troubleshooting.

To disassemble the computer, you need the following tools:

- Wrist grounding strap and conductive mat for preventing electrostatic discharge
- Flat-bladed screw driver
- Phillips screw driver
- Tweezers
- Flat-bladed screw driver or plastic stick

NOTE: The screws for the different components vary in size. During the disassembly process, group the screws with the corresponding components to avoid mismatch when putting back the components.

General Information

Before You Begin

Before proceeding with the disassembly procedure, make sure that you do the following:

1. Turn off the power to the system and all peripherals.
2. Unplug the AC adapter and all power and signal cables from the system.
3. Remove the battery pack.

Disassembly Procedure Flowchart

The flowchart on the succeeding page gives you a graphic representation on the entire disassembly sequence and instructs you on the components that need to be removed during servicing. For example, if you want to remove the system board, you must first remove the keyboard, then disassemble the inside assembly frame in that order.

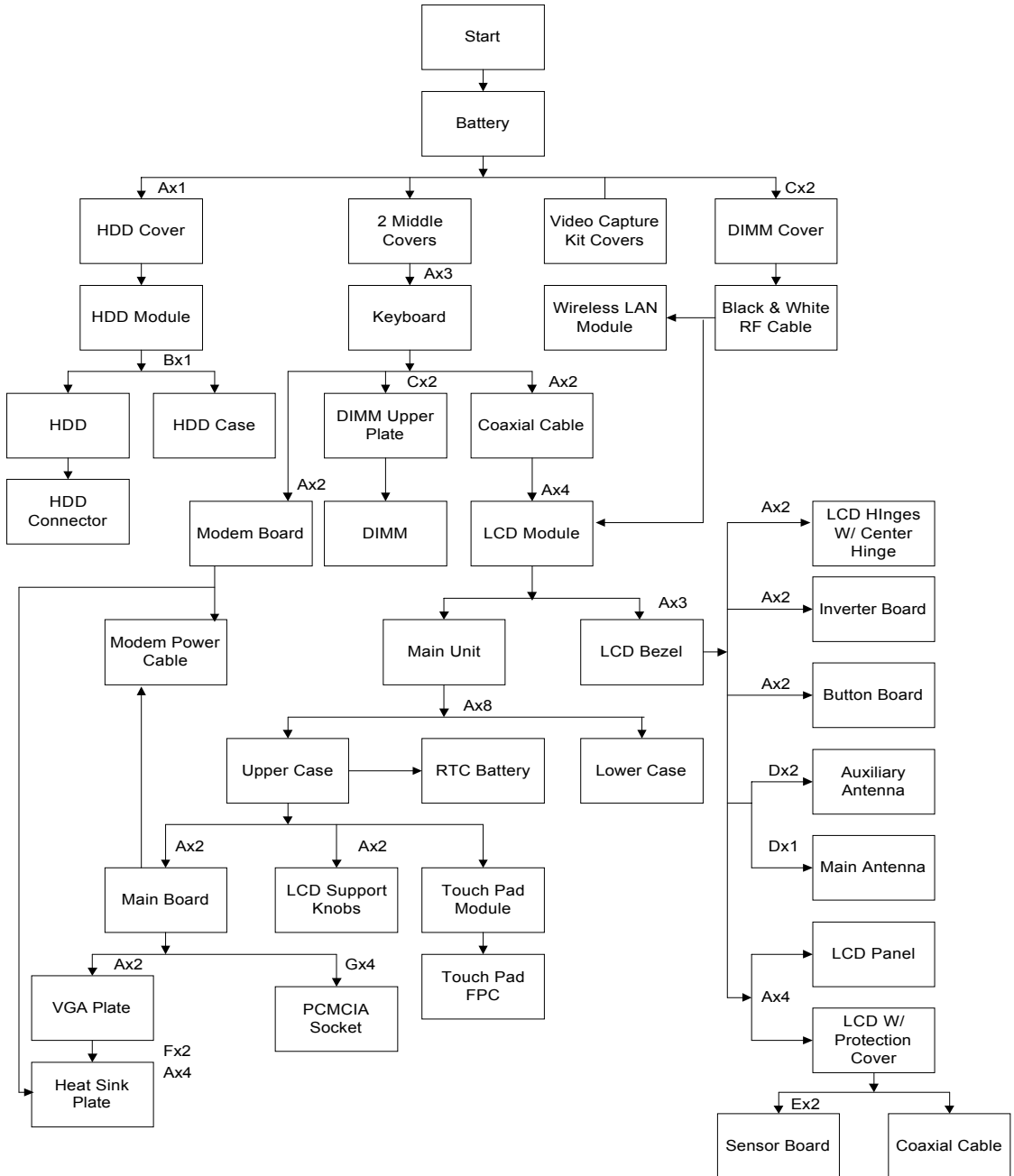

Screw List

Item	Description
A	Screw M2.5 X L6 (Black)
B	Screw M3 X L4 (Silver)
C	Screw M2 X L4 ((Black)
D	Screw M2 X L4 (Silver)
E	Screw M2 X L4.5 (Golden)
F	Hex Screw (Silver)
G	Screw M2 X L4 (Black)

Removing the Battery Pack

1. Push the battery lock latch forward to unlock the battery.
2. Push the battery release latch to release the battery.
3. Remove the battery.



Removing the Wireless LAN Module

1. See “Removing the Battery Pack” on page 47
2. First remove the two screws as shown here, and then lift the DIMM cover up.

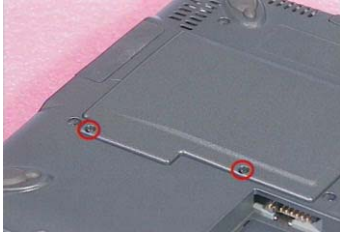

3. Detach the gray and black RF cables from the wireless LAN module.



4. Push the two latches on both sides of the socket to release the wireless LAN module. Remove the wireless LAN module..



Removing the Hard Disk Drive Module

1. See “Removing the Battery Pack” on page 47
2. Remove the screw of the HDD cover, then remove the HDD cover.
3. Remove the HDD module in the way as shown here.



Disassembling the Hard Disk Drive Module

1. See “Removing the Battery Pack” on page 47
2. See “Removing the Hard Disk Drive Module” on page 49
3. Remove the one silver screw, and then detach the HDD module out from the HDD case. Detach the HDD connector from the HDD.



Disassembling the Main Unit

Removing the Middle Covers

1. See “Removing the Battery Pack” on page 47
2. First, push outward the middle cover as shown here, and then detach the other middle cover on the rear of the unit.



NOTE: The disassembly procedures of the middle covers are reversed due to the change of the material which the middle covers are made of. Please ignore the disassembly procedures for this part in the video.

Removing the Keyboard

1. See “Removing the Battery Pack” on page 47
2. See “Removing the Middle Covers” on page 50
3. Remove the three screws, lift the keyboard upward, and then put it on the upper case as shown here.

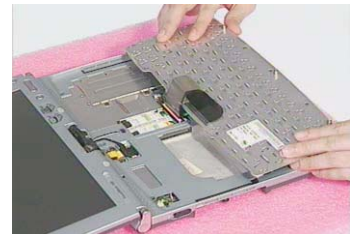

4. Disconnect the keyboard cable from the main board by using a plastic flat screwdriver and remove the keyboard.

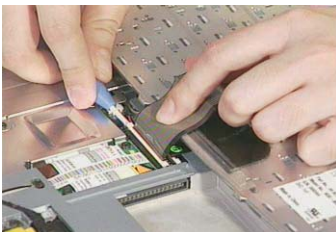

Removing the LCD Module

1. See “Removing the Battery Pack” on page 47
2. See “Removing the Middle Covers” on page 50
3. See “Removing the Keyboard” on page 50
4. Remove the two screws as shown here, and then disconnect the LCD coaxial cable from the main board. Disconnect the inverter cable from the main board



5. Pull up the two RF cables with the tweezers gently. Remove the two screws and the other two on the center hinge.

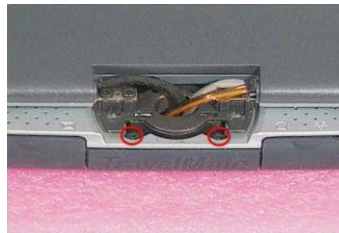
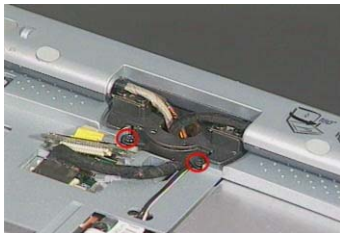

6. Press the two LCD support knobs inward and then remove the LCD module from the main unit.



NOTE: We would like to highlight the correct way to rotate the LCD module here. Please note that the LCD module can only be rotated at 180 degrees. Rotating the LCD module in the wrong direction may cause the damage to the cables.

1. Pressing the two LCD support knobs inward, rotate the LCD module clockwise at 180 degrees.

|



2. To rotate the LCD module back to its original position, rotate the LCD module counterclockwise at 180 degrees. Press the two LCD support knobs to secure the LCD module well.



Removing the DIMM Upper Plate

1. See “Removing the Battery Pack” on page 47
2. See “Removing the Middle Covers” on page 50
3. See “Removing the Keyboard” on page 50
4. Remove the two screws, and then detach the DIMM upper plate from the heat sink plate.

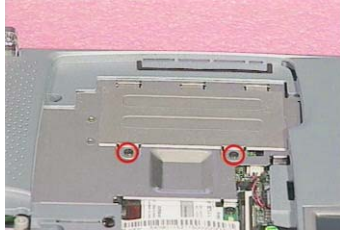

Removing the Internal Memory Module

1. See “Removing the Battery Pack” on page 47
2. See “Removing the Middle Covers” on page 50
3. See “Removing the Keyboard” on page 50
4. See “Removing the DIMM Upper Plate” on page 53
5. Push the latches on both sides of the socket to release the DIMM, and then remove the DIMM from the main unit.



Removing the Modem Board

1. See “Removing the Battery Pack” on page 47
2. See “Removing the Middle Covers” on page 50
3. See “Removing the Keyboard” on page 50
4. Remove the two screws, disconnect the modem cable from the modem board, and then detach the modem board from the main board



Separating the Upper Case from the Lower Case

1. See “Removing the Battery Pack” on page 47
2. See “Removing the Middle Covers” on page 50
3. See “Removing the Keyboard” on page 50
4. See “Removing the LCD Module” on page 51
5. Disconnect the touch pad cable from the main board with a plastic flat screwdriver.
6. Disconnect the cover switch cable and RTC cable from the main board respectively.



7. Turn over the machine, please note that the machine should be put on a sponge with the two LCD support knobs against the edge of the sponge. Remove the eight screws at the back side of the main unit.

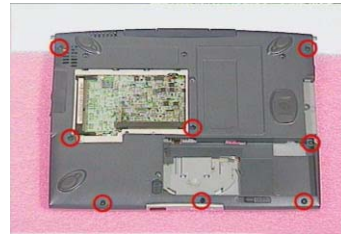

8. Release the RJ 11 & RJ45 rubber door and the USB rubber door. (Please do not remove the two rubber doors from the main unit. Separate the upper case from the lower case.



Removing the RTC Battery

1. See “Removing the Battery Pack” on page 47
2. See “Removing the Middle Covers” on page 50
3. See “Removing the Keyboard” on page 50
4. See “Removing the LCD Module” on page 51
5. See “Separating the Upper Case from the Lower Case” on page 54
6. Remove the tape and then detach the RTC battery from the upper case carefully.

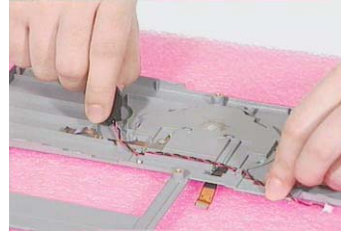
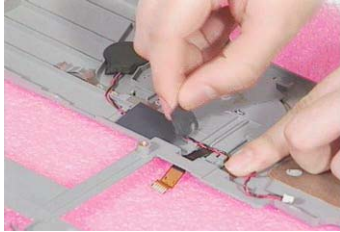

Removing the Touch Pad Module

1. See “Removing the Battery Pack” on page 47
2. See “Removing the Middle Covers” on page 50
3. See “Removing the Keyboard” on page 50
4. See “Removing the LCD Module” on page 51
5. See “Separating the Upper Case from the Lower Case” on page 54
6. First release the latches in the way as shown here. Snap off the touch pad module from the upper case carefully.

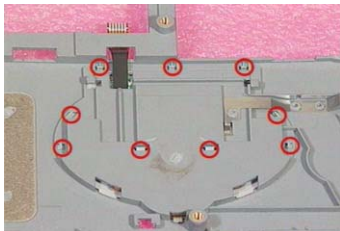

7. Turn the touch pad board over, put it on the upper case, and then disconnect the touch pad cable from the touch pad board. Remove the touch pad board from the upper case

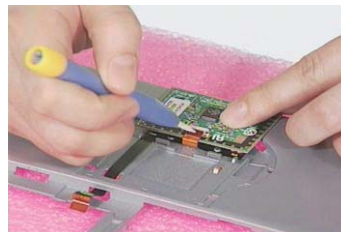

Removing the Touch Pad FPC

1. See “Removing the Battery Pack” on page 47
2. See “Removing the Middle Covers” on page 50
3. See “Removing the Keyboard” on page 50
4. See “Removing the LCD Module” on page 51
5. See “Separating the Upper Case from the Lower Case” on page 54
6. See “Removing the Touch Pad Module” on page 55
7. Remove the touch pad FPC from the upper case as shown below.

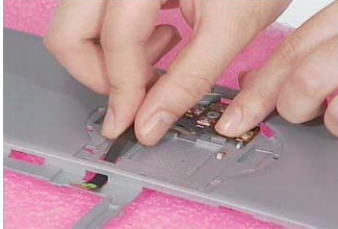

Removing the LCD Support Knobs

1. See “Removing the Battery Pack” on page 47
2. See “Removing the Middle Covers” on page 50
3. See “Removing the Keyboard” on page 50
4. See “Removing the LCD Module” on page 51
5. See “Separating the Upper Case from the Lower Case” on page 54
6. Remove the two screws as shown, and then use a plastic flat screwdriver to help remove the left and right LCD support knobs consecutively

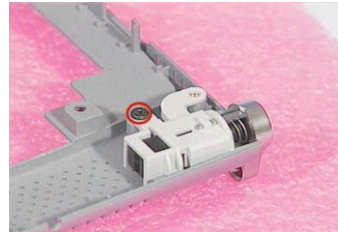

Removing the System Board

1. See “Removing the Battery Pack” on page 47
2. See “Removing the Middle Covers” on page 50
3. See “Removing the Keyboard” on page 50
4. See “Removing the LCD Module” on page 51
5. See “Separating the Upper Case from the Lower Case” on page 54
6. Disconnect the sensor switch & microphone cable from the audio board connector on the main board and then remove the two screws on the main board as shown below. Remove the main board from the lower case with caution..

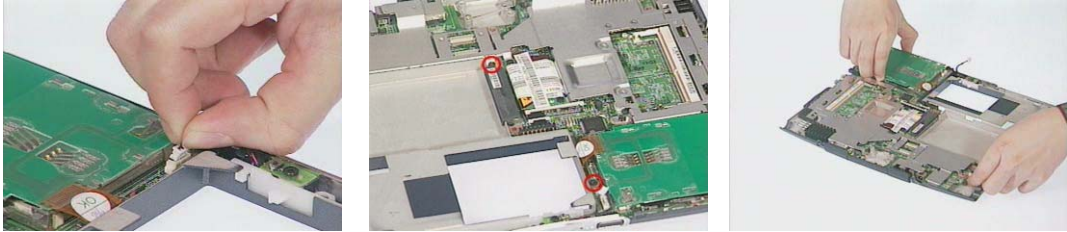

Removing the PCMCIA Socket

1. See “Removing the Battery Pack” on page 47
2. See “Removing the Middle Covers” on page 50
3. See “Removing the Keyboard” on page 50
4. See “Removing the LCD Module” on page 51
5. See “Separating the Upper Case from the Lower Case” on page 54
6. See “Removing the System Board” on page 57
7. Remove the smart card FPC from the mainboard and the four screws.

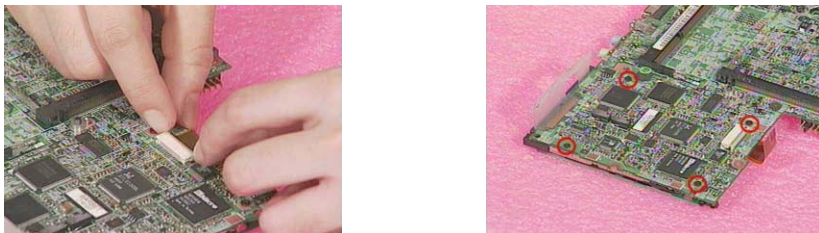

8. Press the PC card eject button, and then remove the CardBus dummy card. Detach the PCMCIA socket from the main board.

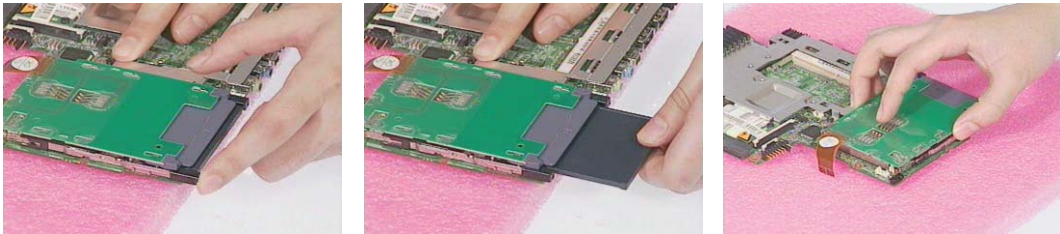

Removing the VGA Plate

1. See “Removing the Battery Pack” on page 47
2. See “Removing the Middle Covers” on page 50
3. See “Removing the Keyboard” on page 50
4. See “Removing the LCD Module” on page 51
5. See “Separating the Upper Case from the Lower Case” on page 54
6. See “Removing the System Board” on page 57
7. Remove the two screws and then remove the VGA plate from the main board

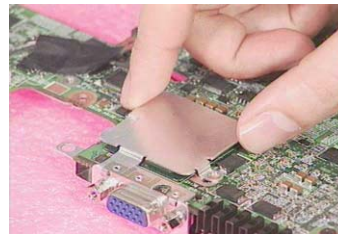

Removing the Heat Sink Plate

1. See “Removing the Battery Pack” on page 47
2. See “Removing the Middle Covers” on page 50
3. See “Removing the Keyboard” on page 50
4. See “Removing the LCD Module” on page 51
5. See “Removing the Modem Board” on page 53
6. See “Separating the Upper Case from the Lower Case” on page 54
7. See “Removing the System Board” on page 57
8. See “Removing the VGA Plate” on page 58

9. Release the four black screws and two hex screws as shown here.

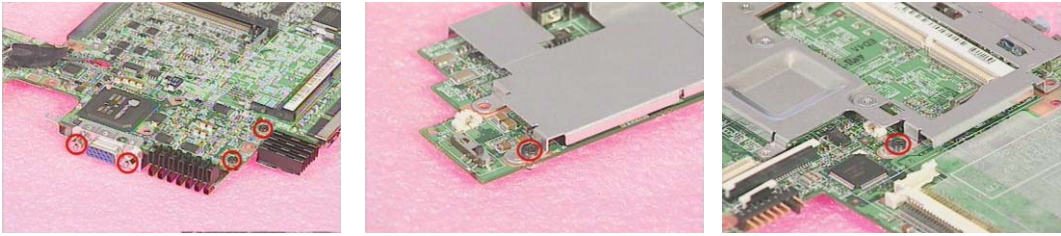

10. Lift and pull the main board backward, and then slide the main board out from the heat sink plate in the direction at 45 degree as shown here.

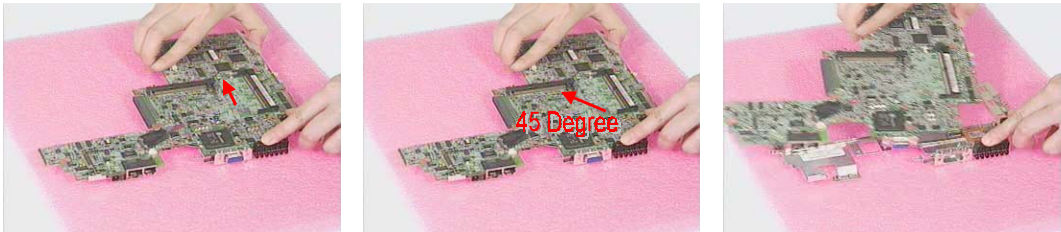

Removing the Modem Cable

1. See “Removing the Battery Pack” on page 47
2. See “Removing the Middle Covers” on page 50
3. See “Removing the Keyboard” on page 50
4. See “Removing the LCD Module” on page 51
5. See “Removing the Modem Board” on page 53
6. See “Separating the Upper Case from the Lower Case” on page 54
7. See “Removing the System Board” on page 57
8. Detach the tape, and then disconnect the modem cable from the main board.
9. Remove the modem cable

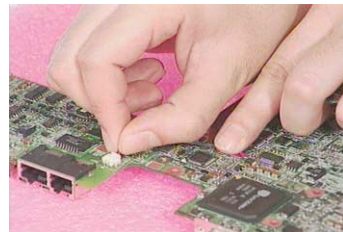
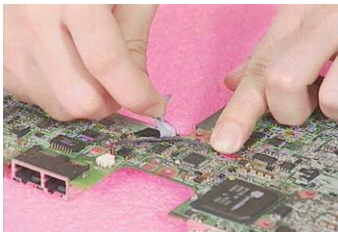

Disassembling the LCD Module

Removing the LCD Bezel

1. See “Removing the Battery Pack” on page 47
2. See “Removing the Middle Covers” on page 50
3. See “Removing the Keyboard” on page 50
4. See “Removing the LCD Module” on page 51
5. Remove the stylus and the two video capture kit covers.



6. Remove the three LCD screw cushions and then the three screws on the LCD bezel..



7. Snap off the LCD bezel carefully, and then detach the LCD bezel from the LCD module



Removing the LCD Hinges with the Center Hinge

1. See “Removing the Battery Pack” on page 47
2. See “Removing the Middle Covers” on page 50
3. See “Removing the Keyboard” on page 50
4. See “Removing the LCD Module” on page 51
5. See “Removing the LCD Bezel” on page 60
6. Pull the cables out from the center hinge, remove the two screws, push the cables out through the center hinge and then remove the LCD hinges together with the center hinge from the LCD panel.

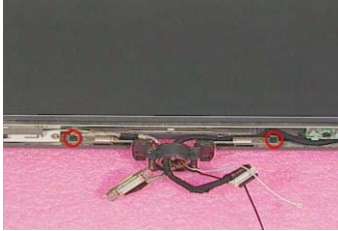

NOTE: Do not detach the LCD hinges from the center hinge. The disassembly procedures of this part should stop here as shown above. Please ignore the parts of detaching the LCD hinges from the center hinge in the video.

Removing the Button Board & Inverter Board

1. See “Removing the Battery Pack” on page 47
2. See “Removing the Middle Covers” on page 50
3. See “Removing the Keyboard” on page 50
4. See “Removing the LCD Module” on page 51
5. See “Removing the LCD Bezel” on page 60
6. Remove the two screws on the button board, and the other two screws on the inverter board respectively.

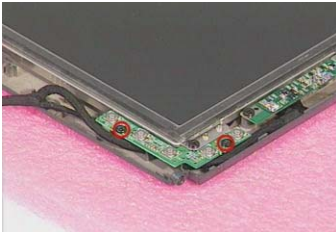

7. Disconnect the LCD power cable from the inverter board and then detach the button board together with inverter board from the LCD panel carefully.. Disconnect inverter cable from the inverter board.



Removing the Main and Auxiliary Antenna

1. See “Removing the Battery Pack” on page 47
2. See “Removing the Middle Covers” on page 50
3. See “Removing the Keyboard” on page 50
4. See “Removing the LCD Module” on page 51
5. See “Removing the LCD Bezel” on page 60
6. Remove the one silver screw and the other two silver screws as shown below. Detach the main antenna at the top and auxiliary antenna at the bottom from the LCD module.



NOTE: When you reassemble the machine, please remember to put the two antennas back with the small latches installed well and the two RF cables arranged well.

Removing the LCD

1. See “Removing the Battery Pack” on page 47
2. See “Removing the Middle Covers” on page 50
3. See “Removing the Keyboard” on page 50
4. See “Removing the LCD Module” on page 51
5. See “Removing the LCD Bezel” on page 60
6. Remove the four screws and then detach the LCD together with the protection cover from the LCD panel carefully.



NOTE: Please do not detach the protection cover from the LCD. The intention to do so will cause the damage to the protection cover and the LCD.

Removing the Coaxial Cable

1. See “Removing the Battery Pack” on page 47
2. See “Removing the Middle Covers” on page 50
3. See “Removing the Keyboard” on page 50
4. See “Removing the LCD Module” on page 51
5. See “Removing the LCD Bezel” on page 60
6. See “Removing the LCD” on page 62
7. Remove the tape, disconnect the coaxial cable, and then remove the coaxial cable from the LCD carefully.

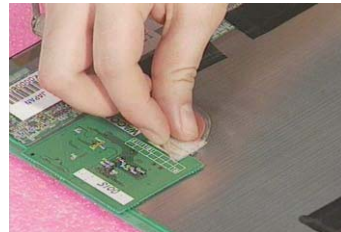

Removing the Sensor Board

1. See “Removing the Battery Pack” on page 47
2. See “Removing the Middle Covers” on page 50
3. See “Removing the Keyboard” on page 50
4. See “Removing the LCD Module” on page 51
5. See “Removing the LCD Bezel” on page 60
6. See “Removing the LCD” on page 62
7. Remove the two golden screws, remove the tapes and then detach the sensor board from the LCD carefully.

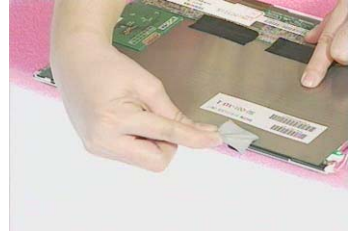

Troubleshooting

Use the following procedure as a guide for computer problems.

NOTE: The diagnostic tests are intended to test only Acer products. Non-Acer products, prototype cards, or modified options can give false errors and invalid system responses.

1. Obtain the failing symptoms in as much detail as possible.
2. Verify the symptoms by attempting to re-create the failure by running the diagnostic test or by repeating the same operation.
3. Use the following table with the verified symptom to determine which page to go to.

Symptoms (Verified)	Go To
Power failure. (The power indicator does not go on or stay on.)	"Power System Check" on page 67.
POST does not complete. No beep or error codes are indicated.	"Power-On Self-Test (POST) Error Message" on page 70 "Undetermined Problems" on page 78
POST detects an error and displayed messages on screen.	"Error Message List" on page 71
The diagnostic test detected an error and displayed a FRU code.	"System Diagnostic Diskette" on page 40
Other symptoms (i.e. LCD display problems or others).	"Power-On Self-Test (POST) Error Message" on page 70
Symptoms cannot be re-created (intermittent problems).	Use the customer-reported symptoms and go to "Power-On Self-Test (POST) Error Message" on page 70 "Intermittent Problems" on page 77 "Undetermined Problems" on page 78

System Check Procedures

External Diskette Drive Check

Do the following to isolate the problem to a controller, driver, or diskette. A write-enabled, diagnostic diskette is required.

NOTE: Make sure that the diskette does not have more than one label attached to it. Multiple labels can cause damage to the drive or cause the drive to fail.

Do the following to select the test device. See “System Diagnostic Diskette” on page 40 for details.

1. Boot from the diagnostics diskette and start the PQA program (see “System Diagnostic Diskette” on page 40).
2. Go to the diagnostic Diskette Drive in the test items.
3. Press **F2** in the test items.
4. Follow the instructions in the message window.

If an error occurs with the internal diskette drive, reconnect the diskette connector on the system board.

If the error still remains:

1. Reconnect the external diskette drive/CD-ROM module.
2. Replace the external diskette drive/CD-ROM module.
3. Replace the system board.

External CD-ROM Drive Check

Do the following to isolate the problem to a controller, drive, or CD-ROM. Make sure that the CD-ROM does not have any label attached to it. The label can cause damage to the drive or can cause the drive to fail.

Do the following to select the test device:

1. Boot from the diagnostics diskette and start the PQA program (refer to “System Diagnostic Diskette” on page 40).
2. Go to the diagnostic CD-ROM in the test items.
3. Press **F2** in the test items.
4. Follow the instructions in the message window.

If an error occurs, reconnect the connector on the System board. If the error still remains:

1. Reconnect the external diskette drive/CD-ROM module.
2. Replace the external diskette drive/CD-ROM module.
3. Replace the system board.

Keyboard or Auxiliary Input Device Check

Remove the external keyboard if the internal keyboard is to be tested.

If the internal keyboard does not work or an unexpected character appears, make sure that the flexible cable extending from the keyboard is correctly seated in the connector on the system board.

If the keyboard cable connection is correct, run the Keyboard Test. See “System Diagnostic Diskette” on page 40 for details.

If the tests detect a keyboard problem, do the following one at a time to correct the problem. Do not replace a non-defective FRU:

1. Reconnect the keyboard cables.
2. Replace the keyboard.
3. Replace the system board.

The following auxiliary input devices are supported by this computer:

- Numeric keypad
- External keyboard

If any of these devices do not work, reconnect the cable connector and repeat the failing operation.

Memory Check

Memory errors might stop system operations, show error messages on the screen, or hang the system.

1. Boot from the diagnostics diskette and start the PQA program (please refer to “System Diagnostic Diskette” on page 40).
2. Go to the diagnostic memory in the test items.
3. Press **F2** in the test items.
4. Follow the instructions in the message window.

NOTE: Make sure that the DIMM is fully installed into the connector. A loose connection can cause an error.

Power System Check

To verify the symptom of the problem, power on the computer using each of the following power sources:

1. Remove the battery pack.
2. Connect the power adapter and check that power is supplied.
3. Disconnect the power adapter and install the charged battery pack; then check that power is supplied by the battery pack.

If you suspect a power problem, see the appropriate power supply check in the following list:

- “Check the Power Adapter” on page 68
- “Check the Battery Pack” on page 69

Check the Power Adapter

Unplug the power adapter cable from the computer and measure the output voltage at the plug of the power adapter cable. See the following figure

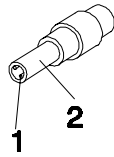

Pin 1: +19 to +20.5V
Pin 2: 0V, Ground

1. If the voltage is not correct, replace the power adapter.
2. If the voltage is within the range, do the following:
 - Replace the System board.
 - If the problem is not corrected, see “Undetermined Problems” on page 78.
 - If the voltage is not correct, go to the next step.

NOTE: An audible noise from the power adapter does not always indicate a defect.

3. If the power-on indicator does not light up, check the power cord of the power adapter for correct continuity and installation.
4. If the operational charge does not work, see “Check the Battery Pack” on page 69.

Check the Battery Pack

To check the battery pack, do the following:

From Software:

1. Check out the Power Management in control Panel
2. In Power Meter, confirm that if the parameters shown in the screen for Current Power Source and Total Battery Power Remaining are correct.
3. Repeat the steps 1 and 2, for both battery and adapter.
4. This helps you identify first the problem is on recharging or discharging.

From Hardware:

1. Power off the computer.
2. Remove the battery pack and measure the voltage between battery terminals 1(+) and 6(ground). See the following figure.

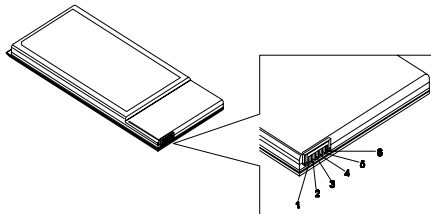

3. If the voltage is still less than 7.5 Vdc after recharging, replace the battery.

To check the battery charge operation, use a discharged battery pack or a battery pack that has less than 50% of the total power remaining when installed in the computer.

If the battery status indicator does not light up, remove the battery pack and let it return to room temperature. Re-install the battery pack.

If the charge indicator still does not light up, replace the battery pack. If the charge indicator still does not light up, replace the DC/DC charger board.

Touchpad Check

If the touchpad doesn't work, do the following actions one at a time to correct the problem. Do not replace a non-defective FRU:

1. Reconnect the touchpad cables.
2. Replace the touchpad.
3. Replace the system board.

After you use the touchpad, the pointer drifts on the screen for a short time. This self-acting pointer movement can occur when a slight, steady pressure is applied to the touchpad pointer. This symptom is not a hardware problem. No service actions are necessary if the pointer movement stops in a short period of time.

Power-On Self-Test (POST) Error Message

The POST error message index lists the error message and their possible causes. The most likely cause is listed first.

NOTE: Perform the FRU replacement or actions in the sequence shown in FRU/Action column, if the FRU replacement does not solve the problem, put the original part back in the computer. Do not replace a non-defective FRU.

This index can also help you determine the next possible FRU to be replaced when servicing a computer.

If the symptom is not listed, see “Undetermined Problems” on page 78.

The following lists the error messages that the BIOS displays on the screen and the error symptoms classified by function.

NOTE: Most of the error messages occur during POST. Some of them display information about a hardware device, e.g., the amount of memory installed. Others may indicate a problem with a device, such as the way it has been configured.

NOTE: If the system fails after you make changes in the BIOS Setup Utility menus, reset the computer, enter Setup and install Setup defaults or correct the error.

Index of Error Messages

Error Code List

Error Codes	Error Messages
006	Equipment Configuration Error Causes: 1. CPU BIOS Update Code Mismatch 2. IDE Primary Channel Master Drive Error 3. IDE Secondary Channel Master Drive Error
010	Memory Error at XXXX:XXXX:XXXXh (R:XXXXh, W:XXXXh)
070	Real Time Clock Error
071	CMOS Battery Bad
072	CMOS Checksum Error
110	Incorrect password specified, system disabled. (Text mode only)
<No Error Code>	Battery critical low In this situation, BIOS will issue 4 short beeps that shut down the system. No message will be shown.
<No Error Code>	Thermal critical high In this situation, BIOS will issue 3 long beeps then shut down the system.

Error Message List

Error Messages	FRU/Action in Sequence
Failure Fixed Disk	Reconnect hard disk drive connector. "Load Default Settings" in BIOS Setup Utility. Hard disk drive System board
Stuck Key	see "Keyboard or Auxiliary Input Device Check" on page 67 .
Keyboard error	see "Keyboard or Auxiliary Input Device Check" on page 67.
Keyboard Controller Failed	see "Keyboard or Auxiliary Input Device Check" on page 67.
Keyboard locked - Unlock key switch	Unlock external keyboard
Monitor type does not match CMOS - Run Setup	Run "Load Default Settings" in BIOS Setup Utility.
Shadow RAM Failed at offset: nnnn	BIOS ROM System board
System RAM Failed at offset: nnnn	DIMM System board
Extended RAM Failed at offset: nnnn	DIMM System board
System battery is dead - Replace and run Setup	Replace RTC battery and Run BIOS Setup Utility to reconfigure system time, then reboot system.
System CMOS checksum bad - Default configuration used	RTC battery Run BIOS Setup Utility to reconfigure system time, then reboot system.
System timer error	RTC battery Run BIOS Setup Utility to reconfigure system time, then reboot system. System board

Error Message List

Error Messages	FRU/Action in Sequence
Real time clock error	RTC battery Run BIOS Setup Utility to reconfigure system time, then reboot system. System board
Previous boot incomplete - Default configuration used	Run "Load Default Settings" in BIOS Setup Utility. RTC battery System board
Memory size found by POST differed from CMOS	Run "Load Default Settings" in BIOS Setup Utility. DIMM System board
Diskette drive A error	Check the drive is defined with the proper diskette type in BIOS Setup Utility See "External Diskette Drive Check" on page 66.
Incorrect Drive A type - run SETUP	Check the drive is defined with the proper diskette type in BIOS Setup Utility See "External Diskette Drive Check" on page 66.
System cache error - Cache disabled	System board
CPU ID:	System board
DMA Test Failed	DIMM System board
Software NMI Failed	DIMM System board
Fail-Safe Timer NMI Failed	DIMM System board
Device Address Conflict	Run "Load Default Settings" in BIOS Setup Utility. RTC battery System board
Allocation Error for device	Run "Load Default Settings" in BIOS Setup Utility. RTC battery System board
Failing Bits: nnnn	DIMM BIOS ROM System board
Fixed Disk n	None
Invalid System Configuration Data	BIOS ROM System board
I/O device IRQ conflict	Run "Load Default Settings" in BIOS Setup Utility. RTC battery System board
Operating system not found	Enter Setup and see if fixed disk and drive A: are properly identified. Diskette drive Hard disk drive System board

Error Message List

No beep Error Messages	FRU/Action in Sequence
No beep, power-on indicator turns off and LCD is blank.	Power source (battery pack and power adapter). See "Power System Check" on page 67. Ensure every connector is connected tightly and correctly. Reconnect the DIMM. LED board. System board.
No beep, power-on indicator turns on and LCD is blank.	Power source (battery pack and power adapter). See "Power System Check" on page 67. Reconnect the LCD connector Hard disk drive LCD inverter ID LCD cable LCD Inverter LCD System board
No beep, power-on indicator turns on and LCD is blank. But you can see POST on an external CRT.	Reconnect the LCD connectors. LCD inverter ID LCD cable LCD inverter LCD System board
No beep, power-on indicator turns on and a blinking cursor shown on LCD during POST.	Ensure every connector is connected tightly and correctly. System board
No beep during POST but system runs correctly.	Speaker System board

Error Beep List

Code	Beeps	Description
00h	Two long beeps, one short beep, and then one long beep	Success
F1h	One long, One short beeps	BIOS file size mismatch
F2h	One long, two short beeps	BIOS file reading error
D1h	Two short beeps	Floppy drive not installed

Index of Symptom-to-FRU Error Message

LCD-Related Symptoms

Symptom / Error	Action in Sequence
LCD backlight doesn't work LCD is too dark LCD brightness cannot be adjusted LCD contrast cannot be adjusted	Enter BIOS Utility to execute "Load Setup Default Settings", then reboot system. Reconnect the LCD connectors. Keyboard (if contrast and brightness function key doesn't work). LCD inverter ID LCD cable LCD inverter LCD System board
Unreadable LCD screen Missing pels in characters Abnormal screen Wrong color displayed	Reconnect the LCD connector LCD inverter ID LCD cable LCD inverter LCD System board
LCD has extra horizontal or vertical lines displayed.	LCD inverter ID LCD inverter LCD cable LCD System board

Indicator-Related Symptoms

Symptom / Error	Action in Sequence
Indicator incorrectly remains off or on, but system runs correctly	Reconnect the inverter board Inverter board System board

Power-Related Symptoms

Symptom / Error	Action in Sequence
Power shuts down during operation	Power source (battery pack and power adapter). See "Power System Check" on page 67. Battery pack Power adapter Hard drive & battery connection board System board
The system doesn't power-on.	Power source (battery pack and power adapter). See "Power System Check" on page 67. Battery pack Power adapter Hard drive & battery connection board System board
The system doesn't power-off.	Power source (battery pack and power adapter). See "Power System Check" on page 67. Hold and press the power switch for more than 4 seconds. System board
Battery can't be charged	See "Check the Battery Pack" on page 69. Battery pack System board

PCMCIA-Related Symptoms

Symptom / Error	Action in Sequence
System cannot detect the PC Card (PCMCIA)	PCMCIA slot assembly System board
PCMCIA slot pin is damaged.	PCMCIA slot assembly

Memory-Related Symptoms

Symptom / Error	Action in Sequence
Memory count (size) appears different from actual size.	Enter BIOS Setup Utility to execute "Load Default Settings, then reboot system. DIMM System board

Speaker-Related Symptoms

Symptom / Error	Action in Sequence
In Windows, multimedia programs, no sound comes from the computer.	Audio driver Speaker System board
Internal speakers make noise or emit no sound.	Speaker System board

Power Management-Related Symptoms

Symptom / Error	Action in Sequence
The system will not enter hibernation	Keyboard (if control is from the keyboard) Hard disk drive System board
The system doesn't enter hibernation mode and four short beeps every minute.	See "Hibernation Mode" on page 28. Press Fn+F4 and see if the computer enters hibernation mode. Touchpad Keyboard Hard disk connection board Hard disk drive System board
The system doesn't enter standby mode after closing the LCD	See "Hibernation Mode" on page 28. LCD cover switch System board
The system doesn't resume from hibernation mode.	See "Hibernation Mode" on page 28. Hard disk connection board Hard disk drive System board
The system doesn't resume from standby mode after opening the LCD.	See "Standby Mode" on page 27. LCD cover switch System board
Battery fuel gauge in Windows doesn't go higher than 90%.	Remove battery pack and let it cool for 2 hours. Refresh battery (continue use battery until power off, then charge battery). Battery pack System board

Power Management-Related Symptoms

Symptom / Error	Action in Sequence
System hangs intermittently.	See "Thermal Utility" on page 40. Reconnect hard disk/CD-ROM drives. Hard disk connection board System board

Peripheral-Related Symptoms

Symptom / Error	Action in Sequence
System configuration does not match the installed devices.	Enter BIOS Setup Utility to execute "Load Default Settings", then reboot system. Reconnect hard disk/CD-ROM/diskette drives.
External display does not work correctly.	Press Fn+F5, LCD/CRT/Both display switching See "System Diagnostic Diskette" on page 40. System board
USB does not work correctly	See "System Diagnostic Diskette" on page 40 System board
Print problems.	Ensure the "Parallel Port" in the "Onboard Devices Configuration" of BIOS Setup Utility is set to Enabled. Onboard Devices Configuration Run printer self-test. Printer driver Printer cable Printer System Board
Serial or parallel port device problems.	Ensure the "Serial Port" in the Devices Configuration" of BIOS Setup Utility is set to Enabled. Device driver Device cable Device System board

Keyboard/Touchpad-Related Symptoms

Symptom / Error	Action in Sequence
Keyboard (one or more keys) does not work.	Reconnect the keyboard cable. Keyboard System board
Touchpad does not work.	Reconnect touchpad cable. Touchpad board System board

Modem-Related Symptoms

Symptom / Error	Action in Sequence
Internal modem does not work correctly.	See "System Diagnostic Diskette" on page 40. Modem phone port modem combo board System board

NOTE: If you cannot find a symptom or an error in this list and the problem remains, see "Undetermined Problems" on page 78.

Intermittent Problems

Intermittent system hang problems can be caused by a variety of reasons that have nothing to do with a hardware defect, such as: cosmic radiation, electrostatic discharge, or software errors. FRU replacement should be considered only when a recurring problem exists.

When analyzing an intermittent problem, do the following:

1. Run the advanced diagnostic test for the system board in loop mode at least 10 times.
2. If no error is detected, do not replace any FRU.
3. If any error is detected, replace the FRU. Rerun the test to verify that there are no more errors.

Undetermined Problems

The diagnostic problems does not identify which adapter or device failed, which installed devices are incorrect, whether a short circuit is suspected, or whether the system is inoperative.

Follow these procedures to isolate the failing FRU (do not isolate non-defective FRU).

NOTE: Verify that all attached devices are supported by the computer.

NOTE: Verify that the power supply being used at the time of the failure is operating correctly. (See "Power System Check" on page 67):

1. Power-off the computer.
2. Visually check them for damage. If any problems are found, replace the FRU.
3. Remove or disconnect all of the following devices:
 - Non-Acer devices
 - Printer, mouse, and other external devices
 - Battery pack
 - Hard disk drive
 - DIMM
 - CD-ROM/Diskette drive Module
 - PC Cards
4. Power-on the computer.
5. Determine if the problem has changed.
6. If the problem does not recur, reconnect the removed devices one at a time until you find the failing FRU.
7. If the problem remains, replace the following FRU one at a time. Do not replace a non-defective FRU:
 - System board
 - LCD assembly

Index of AFlash BIOS Error Message

Error Message	Action in Sequence
Hardware Error	See "System Diagnostic Diskette" on page 40
VPD Checksum Error	Reboot the system and then retest with this diskette.
BIOS Update Program Error	Turn off the power and restart the system.
System Error	Make sure this AFlash BIOS diskette for this model.
Without AC adapter	make sure to connect AC adapter
Battery Low	make sure to install a highly charged battery, and reboot system.

Index of PQA Diagnostic Error Code, Message

Error Code	Message	Action in Sequence
16XXX	Backup battery error	Backup battery
01XXX	CPU or main board error	Reload BIOS default setting. System board
02XXX	Memory error	DIMM System board
03XXX	Keyboard error	Reset Keyboard Keyboard System board
04XXX	Video error	System board
05XXX	Parallel Port error	System board
06XXX	Serial port or main board error	System board
07XXX	Diskette drive error	Diskette drive System board
08XXX	Hard disk error	Reload BIOS default setting Hard disk System board
09XXX	CD-ROM error	Reset CD-ROM cable CD-ROM drive System board
10XXX	Co-processor error	System board
11XXX	Pointing device error	Reset Keyboard Keyboard System board
12XXX	Cache test error	System board

Jumper and Connector Locations

Top View

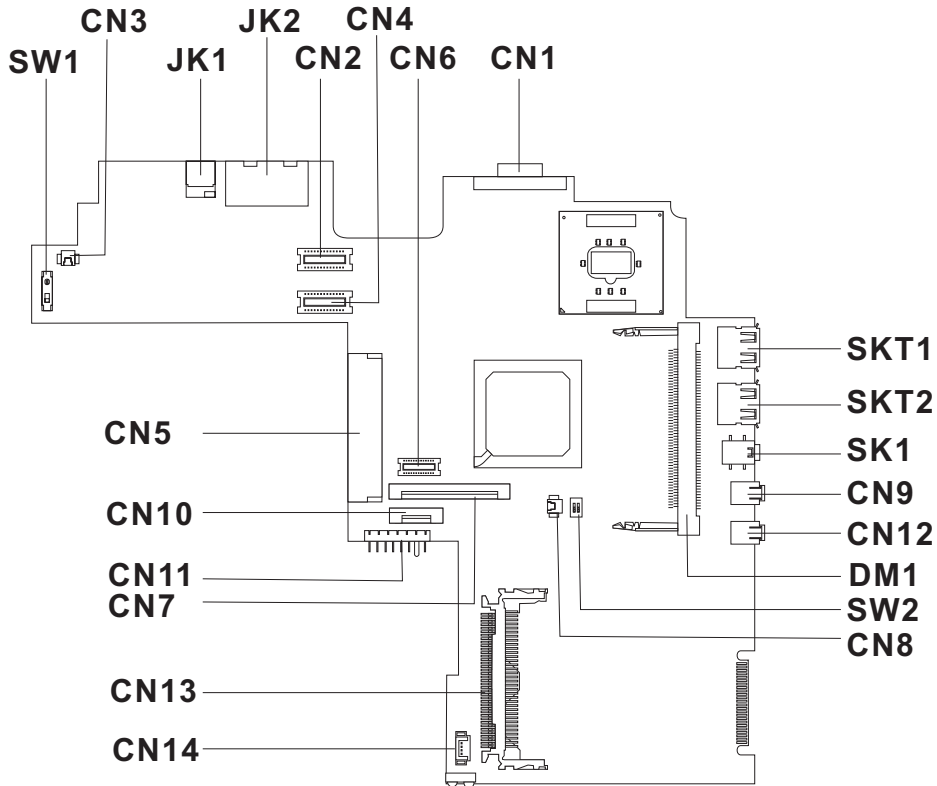

PCB 01201-SD

SW1	Power switch	CN9	Line-in port
CN3	LCD cover switch connector	CN12	Line-out port
JK1	AC adapter connector	DM1	Memory slot 1
JK2	RJ11 and RJ45 connectors	SW2	Please refer to below for SW settings
CN2	LCD coaxial cable connector	CN8	RTC battery connector
CN4	LED/Inverter board connector	CN14	Internal microphone and tablet PC lid connector
CN6	Fax/Modem board connector	CN13	PCMCIA card connector
CN1	VGA port	CN7	Keyboard cable connector
SKT1	USB port 1	CN11	Battery connector
SKT2	USB port 2	CN10	Touchpad connector
SK1	1394 port	CN5	Hard disk drive connector

SW2 Settings

SW4	Setting
Switch 1	ON: Disable password check OFF*: Enable password check
Switch 2	ON: Enable BootBlock Erasable OFF*: Disable BootBlock Erasable

NOTE: *: Default setting

Bottom View

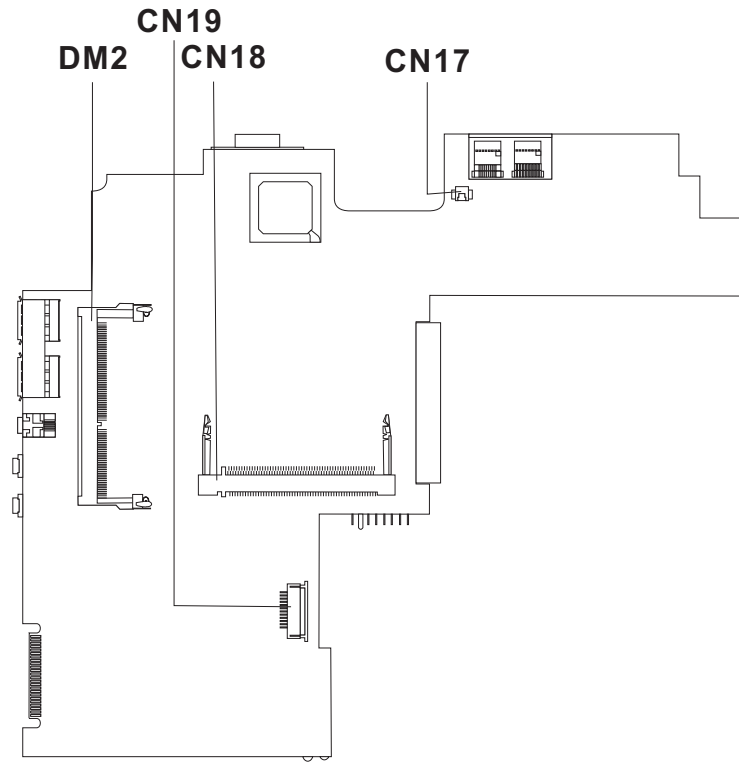

DM2 Memory slot (DM2)
CN19 Smart card connector

CN18 MiniPCI wireless module connector
CN17 Modem cable connector

FRU (Field Replaceable Unit) List







This chapter gives you the FRU (Field Replaceable Unit) listing in global configurations of TravelMate C100. Refer to this chapter whenever ordering for parts to repair or for RMA (Return Merchandise Authorization).

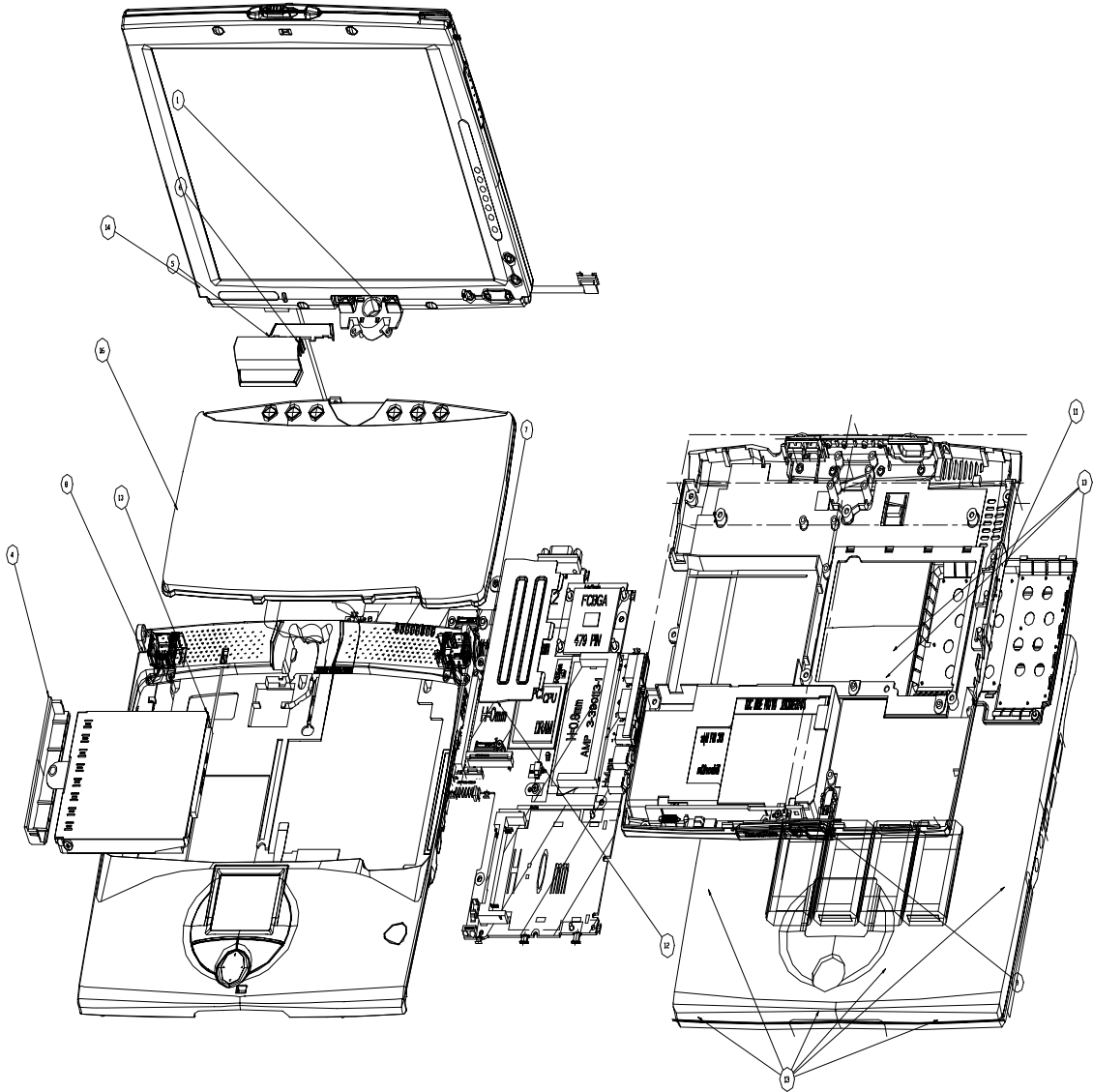





Please note that WHEN ORDERING FRU PARTS, you should check the most up-to-date information available on your regional web or channel. For whatever reasons a part number change is made, it will not be noted on the printed Service Guide. For ACER AUTHORIZED SERVICE PROVIDERS, your Acer office may have a DIFFERENT part number code from those given in the FRU list of this printed Service Guide. You MUST use the local FRU list provided by your regional Acer office to order FRU parts for repair and service of customer machines.

NOTE: To scrap or to return the defective parts, you should follow the local government ordinance or regulations on how to dispose it properly, or follow the rules set by your regional Acer office on how to return it.



Exploded Diagram

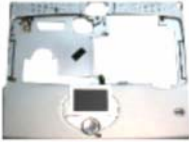



Picture	No.	Partname	Description
Memory			
	NS	MEMORY SODIMM 128MB PC133	SODIMM 128M W17128A4NC8602A
LCD			
	NS	LCD 10.4" TOSHIBA LTM10C321K 01 W/ PROTECTION COVER	ASSY LCD MODULE 10.4" XGA TOSHIBA
Cables			
	NS	RJ11 CABLE	CABLE RJ11
	NS	POWER CORD 125V 3PIN	CORD 125V UL 3P K01081B1183WP
	NS	TOUCH PAD CABLE REX	CABLE FPC TOUCH PAD REX
	NS	INVERTER CABLE	CABLE INVERTER

Picture	No.	Partname	Description
	NS	LCD COAXIAL CABLE	CABLE LCD COAXIAL
Case/Cover/Bracket Assembly			
	11	DIMM COVER	ASSEMBLY DIMM COVER LOW
	9	LOWER CASE	ASSY LOWER CASE
	5	MIDDLE COVER 1	COVER MIDDLE 1
	6	MIDDLE COVER 2	COVER MIDDLE 2
	8	UPPER CASE	ASSEMBLY UPPER CASE
	NS	TOUCH PAD COVER	COVER TOUCH PAD REX M3

Picture	No.	Partname	Description
	NS	HDD CONNECTOR 2R 40PIN	HEAD FML 2R40P ST 1277257-1
	NS	HDD BEZEL	HDD HSG ASSY. (60)
	NS	LCD PANEL W/LOGO/HINGE	ASSEMBLY PANEL
	1	HINGE ASSEMBLY TM C100	ASSEMBLY HINGE TM C100
	NS	LCD BEZEL 10.4"	ASSY LCD BEZEL 10.4 TM C100
Boards			
	NS	MODEM BOARD AMBIT/T60M283.00	MODEM MDC AMBIT/T60M283.00 3A
	NS	LAN BOARD	LAN WIRELESS AG/MPCI- LUC128IAPS

Picture	No.	Partname	Description
	NS	BUTTON BOARD	BARBET (TM C100) BUTTON BOARD
	NS	INVERTER	INVERTER 10.4" DC-AC TWS-458-009
Battery			
	NS	BATTERY ASSEMBLY	ASSEMBLY BATTERY PACKING
Adapter			
	NS	ADAPTER 50W 3PIN 19V	ADT 50W 3P 19V PA-1500-02
Keyboard			
	16	KEYBOARD NSK-A5001 US	KB US NSK-A5001 BARBET (TM C100)
Pointing Device			
	NS	TOUCHPAD BOARD	TOUCHPAD SYNAPTICS TM41P-357
Heatsink			

Picture	No.	Partname	Description
	NS	SYSTEM HEATSINK	ASSEMBLY HEATSINK PLATE
	12	UPPER HEATSINK	ASSEMBLY DIMM UPPER PLATE
HDD/Hard Disk Drive			
	13	HDD MODULE 30G IBM TM C100	ASSY HDD MODULE IBM 30G IBM TM C100
	NS	HDD 30G IBM/IC25N030ATD F80199	HDD 30G IBM/IC25N030ATD F80199
CD-ROM Drive			
	NS	CD ROM-ROM DRIVE AOPEN SC-924U USB	USB CD-ROM AOPEN SC-924U
Communication Module			
	NS	PCMCIA CONNECTOR	CONN CARDBUS & PCMCIA SKT 52539

Picture	No.	Partname	Description
	NS	DIGITIZER SU-001-01WACOM	DIGITIZER SU-001-01WACOM
Main board			
	7	MAINBOARD/TM C100	MB-BARBET TM C100 TULAT700
Miscellaneous			
	NS	LCD LATCH	ASSEMBLY LCD LATCH
	NS	LOGO ACER TM C100	PLATE ACER LOGO REDSTART
	NS	CARDBUS DUMMY CARD	CARDBUS DUMMY CARD TM C100
	NS	CAMERA RUBBER TM C100	RUBBER CAMERA TM C100
Screws			
	NS	SCREW	SCR. HEX NUT W/WASHER #4 NI BT
	NS	SCREW	SCREW DIMM COVER STEEL NAGANO-1
	NS	SCREW	SCREW M2*.0X4 (BLACK)

Picture	No.	Partname	Description
	NS	SCREW	SCREW M2.5X6
	NS	SCREW	SCREW MACH WAFER M2*L4.5 ZN
	NS	SCREW	SCREW M3X4 (86.9A524.4R0)

Model Definition and Configuration

10xT: T: below 12" TFT model

10xTx:

- The first x: define CPU speed. Celeron 500 / ULV Pentium III
 - 0: ULV Celeron 500
 - 1: Intel ULV Pentium III-T CPU 600 MHz
 - 2: Intel ULV Pentium III-T CPU 700 MHz
- The second x: define CD-ROM/DVD/CD-RW

Test Compatible Components

This computer's compatibility is tested and verified by Acer's internal testing department. All of its system functions are tested under Windows XP environment.

Refer to the following list of components, adapter cards and peripherals which have passed this test. Regarding configuration, combination and test procedures please refer to the TravelMate C100 Compatibility Test Report released by Acer Mobile System Testing Department.

Microsoft Windows XP Environment Test

Item	Specifications
Network Adapters	
IBM Ethernet/10baseT/100baseT	3Com EtherLink III 3Com 10/100 16bits Fast EtherLink Xircom Credit Card Ethernet Adapter 10/100 IBM EtherJet PC Card
Token Ring	Madge Smart 16/4 RingNode IBM Turbo 16/4 TokenRing PC Card
Multifunction Card	D-Link Winconnect 33.6 LAN/FAX modem Xircom Credit Card Ethernet 10/100 + Modem 56
CardBus	3Com Megahertz 10/100 LAN CardBus PC Card Intel EtherExpress PRO/100 Mobile Adapter TDK LAN 10/100Base-TX CardBus Card D-Link Fast Ethernet CardBus 10/100 Mbps IBM 10/100 EtherJet CardBus Adapter (32-bit) Xircom CardBus Ethernet 10/100 CBE-10/100BTX
Others	Lucent Wave LAN IEEE 802.11 PCMCIA Card
Modem Adapters	
Modem (up to 56K)	ActionTec DataLink 56Kbps FAX/Modem IBM 56K Double Jack Modem TDK K56Kflex Data/FAX Modem Xircom Credit Card Modem 56 USR Megahertz 56K Modem,
ISDN	IBM ISDN Internet PC Card USR Megahertz ISDN 128K
I/O Peripherals	
I/O Display'	Acer 211c ViewSonic PF790 IBM 9514-B04 TFT monitor AcerView 76i Compaq Color Monitor V70 NEC 20" Color Monitor
I/O - Keyboard	IBM US English Keyboard (PS/AT style) Acer 101 Keyboard Microsoft Natural Keyboard (USB) Compaq Keyboard IBM Numeric Keypad III Chicony Keyboard (USB)
I/O - Mouse	IBM PS/2 Mini Mouse II IBM PS/2 Style Mouse (Black) Logitech Serial Mouse Microsoft IntelliMouse PS/2 Microsoft IntelliMouse USB Microsoft IntelliMouse Optical Logitech USB Wheel Mouse Logitech MouseMan Wheel USB Comb for DOSV & iMac Logitech PS Style Mouse Acer Aspire USB Mouse Logitech USB Wheel Mouse

Item	Specifications
I/O Projector	NEC MultiSync MT-1040
I/O - Parallel (Printer)	IBM Network Printer 17 431200X HP LaserJet 6MP EPSON Stylus Color 740 (USB) Canon USB Printer BJC-430J Canon Color Bubble Jet BJC-600 HP DeskJet 880C
I/O - Parallel (Scanner)	HP ScanJet 3300C Color Scanner (USB) Acer Scan Prisa 620s
I/O - USB	Sanwa USB HUB (Self Power) USB HUB 4 PORT TI-CHIP EIZO I. Station USB HUB Iomega USB ZIP 250MB PC or MAC USB driver ELECOM USB HUB 4-PORT UH-4S 3Com USB 4 port TI-Chip Hub
I/O - USB Modem	Best Data USB 56K V.90 Modem Speakerphone Blaster USB Blaster Modem 56K V9.0
I/O - USB (Speaker)	Panasonic USB Digital Speaker AIWA Multimedia Digital Speaker System (USB) JS USB Digital Speaker
I/O - USB (Joystick)	Microsoft Sidewinder Precision Pro (USB) USB Rockfire Avant Garde Flightstick
I/O - USB Camera	Acer USB Video Capture Kit Intel Digital Camera IBM PC Camera
I/O - USB Ethernet	Belkin USB Ethernet adapter Linksys USB Network Adpter
I/O Adapters	
PCMCIA - SCSI	Adaptec SlimSCSI APA-1460 Adaptec 1480A slim SCSI CB
PCMCIA - ATA	Sundisk 15 MB Viper 170E IBM Travel Kit 340MB microdrive IBM Travel Kit 170MB Microdrive Sony Memory Stick (64MB) + PC Card adapter Epson Flash Packer 6 MB
PCMCIA - CD-ROM	IBM Portable 20x Speed CD-ROM Drive w/ sound JP Panasonic 20x Portable CD-ROM Player
PCMCIA - 1394	Melco IEEE 1394 interface PCMCIA Card Sony DCR TRV-10/ACCKIT M90 1394 Camera w/ Video Capture PC card Lacie IEEE1394 Fire Wire Hard Drive Buffalo IEEE 1394 interface IFC-ILCB/DV Cardbus Card

Online Support Information

This section describes online technical support services available to help you repair your Acer Systems.

If you are a distributor, dealer, ASP or TPM, please refer your technical queries to your local Acer branch office. Acer Branch Offices and Regional Business Units may access our website. However some information sources will require a user i.d. and password. These can be obtained directly from Acer CSD Taiwan.

Acer's Website offers you convenient and valuable support resources whenever you need them.

In the Technical Information section you can download information on all of Acer's Notebook, Desktop and Server models including:

- Service guides
- User's manuals
- Training materials
- Main manuals
- Bios updates
- Software utilities
- Spare parts lists
- Chips
- TABs (Technical Announcement Bulletin)

For these purposes, we have included an Acrobat File to facilitate the problem-free downloading of our technical material.

Also contained on this website are:

- Detailed information on Acer's International Traveller's Warranty (ITW)
- Returned material authorization procedures
- An overview of all the support services we offer, accompanied by a list of telephone, fax and email contacts for all your technical queries.

We are always looking for ways to optimize and improve our services, so if you have any suggestions or comments, please do not hesitate to communicate these to us.

A

- AC Adapter 26
- ACPI 1.0a 20
- AFLASH Utility 40
- APM 1.2 20
- Audio 23, 24

B

- Battery 25
- Battery Pack 47
- battery pack
 - charging indicator 12
- BIOS 20
 - package 20
 - password control 20
 - ROM size 20
 - ROM type 20
 - vendor 20
 - Version 20
- BIOS Setup Utility 31
- BIOS Supports protocol 20
- BIOS Utility 31–39
 - Basic System Settings 34
 - Load Default Settings 39
 - Navigating 31
 - Onboard Device Configuration 37
 - Startup Configuration 35
 - System Information 32
 - System Security 37
- Board Layout 4
 - Bottom View 5
 - Top View 4
- brightness
 - hotkeys 16

C

- Cache
 - controller 20
 - size 20
- caps lock
 - on indicator 12
- CardBus 24
- computer
 - on indicator 12
- Core logic 24

CPU

- core voltage 20
- I/O voltage 20
- package 20
- type 20

D

- DIMM 20
 - Combinations 21
 - package 20
 - Speed 20
 - voltage 20
- Disassembly
 - Battery Pack 47
 - LCD Module 51
 - Machine 43
 - Procedure Flowchart 45
- Display 3
- display
 - hotkeys 16
- Display Standby Mode 28
- DMA Channel Assignment 30
- DVD-ROM Interface 22

E

- Environmental Requirements 28
- Error Symptom-to-Spare Part Index 70
- External CD-ROM Drive Check 66
- External Diskette Drive Check 66

F

- Features 1
- FIR 24
- Flash Utility 40
- Floppy Disk Drive Interface 21
- FRU (Field Replaceable Unit) List 85

H

- Hard disk 22, 24
- Hard Disk Standby Mode 28
- Hardware Specifications and Configurations 20
- HDD 22, 24
- Hibernation Mode 28
- Hibernation mode

hotkey 16
Hot Keys 13

I

I/O Address Map 29
Indicators 12
Intermittent Problems 77
IrDA 24
IRQ Assignment Map 30

J

Jumper and Connector Locations 81
Top View 81

K

Keyboard 24
Removing 50
Keyboard or Auxiliary Input Device Check 67

L

L2 cache 20
LAN/Modem Combo 21
LCD 25
DC-AC LCD Inverter 25
LCD Bezel
Removing 60

M

Machine Disassembly 43
Mechanical Specification 28
media access
on indicator 12
Memory
Address Map 29
Memory Address Map 29
Memory Check 67
Microsoft Windows XP Environment Test 98
Modem 21
Modem Power Cable
Removing 59

N

Notebook Manager
hotkey 16
num lock
on indicator 12

O

Online Support Information 101

P

Panel 6
Bottom 11
left 6
Rear 9
right 9
Password Setting
Hard Disk Password 38
Power-On Password 38
Setup Password 38
PC Card 12, 20, 24
PCMCIA 24
Power Management 27
Power System Check 67
Battery Pack 69
Power Adapter 68
PQA 40
Processor 20

R

RMA 85
RTC 24

S

Screw List 46
Second Level Cache 20
speakers
hotkey 16
Standby Mode 27
Super I/O 24
System
Block Diagram 3
Layout 4
System Board
Removing 57
System Check Procedures 66
System Diagnostic Diskette 40
System Memory 20
System Utilities 31
System Utility Diskette 40

T

Temperature 28
Test Compatible Components 97
touchpad
hotkey 16
Touchpad Check 69

TouchPad Module
 Removing 55
Troubleshooting 65

U

Undetermined Problems 78
USB 24

utility
 BIOS 31–39

V

Video 23
 Resolutions 23
Video controller 24

